



Gynäkologie
Gynecology

Gynécologie
Ginecología
Ginecologia

Scheidenspekula
Vaginal specula

Spéculums vaginaux
Espéculos vaginales
Specoli vaginali



Standard Scheidenspekula

Standard Vaginal specula

Standard Spéculum vaginaux

Standard Espéculos vaginales

standard Specoli vaginali



isoliert - für HF-Chirurgie mit Rauchabsaugung

insulated - for HF Surgery (Radio Frequency), with smoke evacuation

isolés - pour la chirurgie à haute fréquence, avec aspiration de la fumée

Aislados - para la cirugía por alta frecuencia, con aspiración de humo

Isolati - per la chirurgia ad alta frequenza, con aspirazione di fumo



Antireflex - für Laser-Chirurgie mit Rauchabsaugung

Antireflex - for Laser Surgery (Radio Frequency), with smoke evacuation

Antireflexe - pour la chirurgie au laser, avec aspiration de la fumée

Antireflejos - para la cirugía por laser, con aspiración de humo

Antiriflesso - per la chirurgia laser, con aspirazione di fumo



Scheidenspekula
Vaginal specula

Spéculums vaginaux
Espéculos vaginales
Specoli vaginali



Cusco



75 mm x 32 mm	tk 34001-01	tk 34001-51	tk 34001-61
85 mm x 35 mm	tk 34001-02	tk 34001-52	tk 34001-62
100 mm x 35 mm	tk 34001-03	tk 34001-53	tk 34001-63

75 mm x 17 mm	tk 34005-04	-	-
---------------	--------------------	---	---

für Jungfrauen
for virgins

pour vierges
para virgenes
per vergine



Cusco



75 mm x 32 mm	tk 34007-01
85 mm x 35 mm	tk 34007-02
100 mm x 37 mm	tk 34007-03

Scheidenspekula
Vaginal specula

Spéculums vaginaux
Espéculos vaginales
Specoli vaginali

Cusco	<input type="checkbox"/>
80 mm x 22 mm	tk 34012-01
100 mm x 25 mm	tk 34012-02
105 mm x 27 mm	tk 34012-03

Schweizer Modell
Swiss pattern
Modèle suisse
Modelo suizo
Modello svizzero

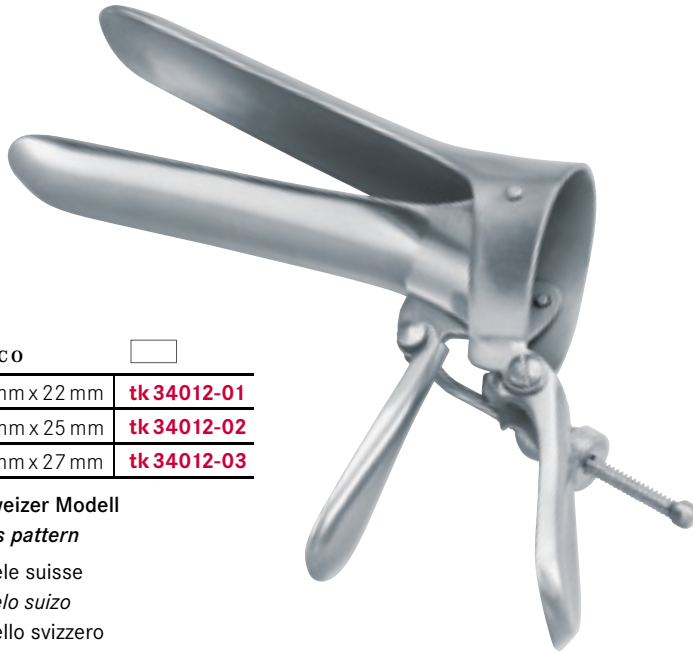

GRAVE	<input type="checkbox"/>	<input checked="" type="checkbox"/>	<input type="checkbox"/>
75 mm x 20 mm	tk 34015-01	tk 34015-53	tk 34015-61
95 mm x 35 mm	tk 34015-02	tk 34015-52	tk 34015-62
115 mm x 35 mm	tk 34015-03	tk 34015-51	tk 34015-63

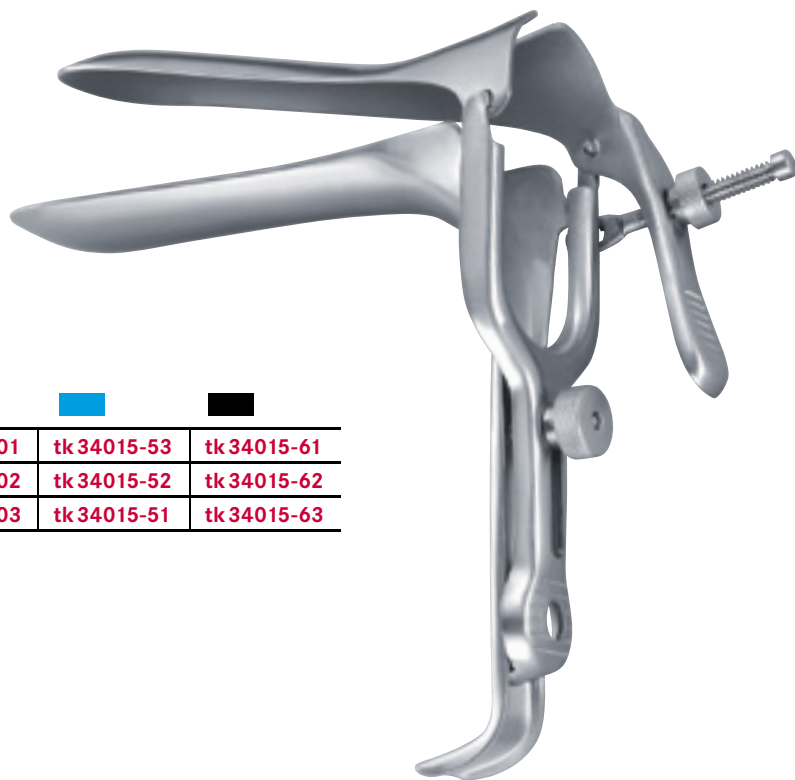

Scheidenspekula
Vaginal specula

Spéculums vaginaux
Espéculos vaginales
Specoli vaginali

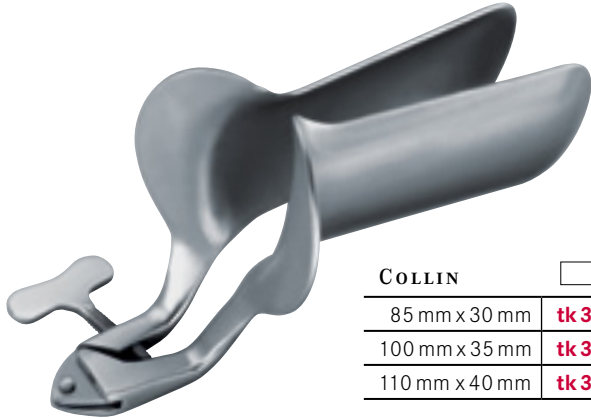

COLLIN	<input type="checkbox"/>	<input type="checkbox"/>	<input type="checkbox"/>
85 mm x 30 mm	tk 34018-01	tk 34018-53	tk 34018-61
100 mm x 35 mm	tk 34018-02	tk 34018-52	tk 34018-62
110 mm x 40 mm	tk 34018-03	tk 34018-51	tk 34018-63

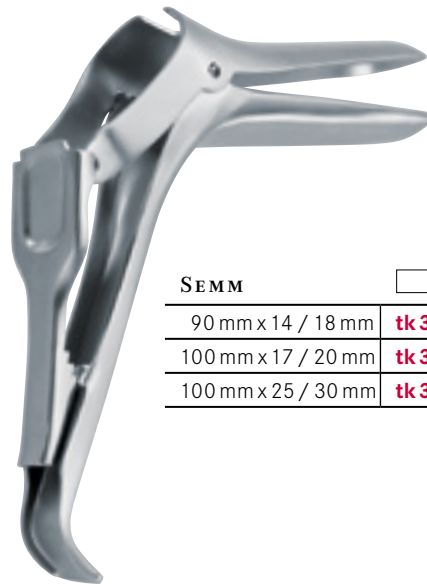

SEMM	<input type="checkbox"/>
90 mm x 14 / 18 mm	tk 34020-00
100 mm x 17 / 20 mm	tk 34020-01
100 mm x 25 / 30 mm	tk 34020-02

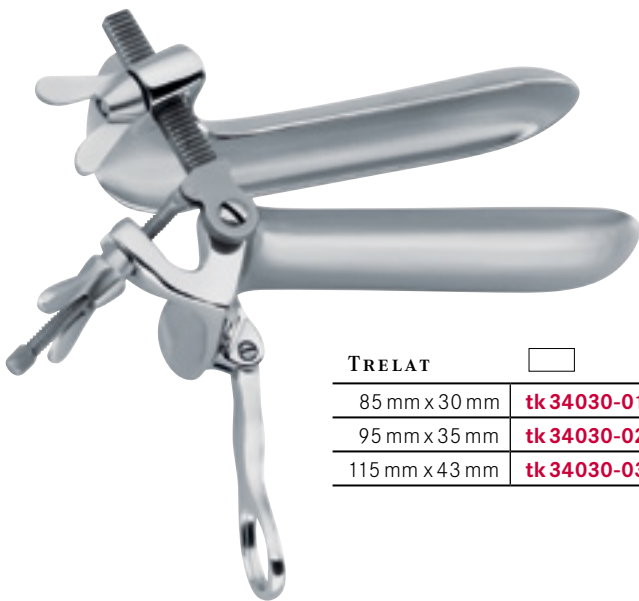

TRELAT	<input type="checkbox"/>
85 mm x 30 mm	tk 34030-01
95 mm x 35 mm	tk 34030-02
115 mm x 43 mm	tk 34030-03



PEDERSON	<input type="checkbox"/>
75 mm x 13 mm	tk 34032-01
100 mm x 22 mm	tk 34032-02
120 mm x 25 mm	tk 34032-03

Scheidenspekula
Vaginal specula

Spéculums vaginaux
Espéculos vaginales
Specoli vaginali



KRISTELLER

70 mm x 27 mm	tk 34050-01
80 mm x 30 mm	tk 34050-02
90 mm x 36 mm	tk 34050-03
110 mm x 27 mm	tk 34050-04
110 mm x 30 mm	tk 34050-05
110 mm x 36 mm	tk 34050-06

Spekulum
Speculum
Spéculum
Espéculo
Specolo



75 mm x 23 mm	tk 34051-01
85 mm x 26 mm	tk 34051-02
100 mm x 32 mm	tk 34051-03
115 mm x 23 mm	tk 34051-04
115 mm x 26 mm	tk 34051-05
115 mm x 32 mm	tk 34051-06

Halter
Retractor
Valve
Valva
Valve



tk 34052-01
tk 34052-02
tk 34052-03
tk 34052-04
tk 34052-05
tk 34052-06

Satz
Set
Jeu
Juego
Serie

Scheidenspekula
Vaginal specula

Spéculums vaginaux
Espéculos vaginales
Specoli vaginali



KRISTELLER

105mm x 18 mm	tk 34055-01
105 mm x 21 mm	tk 34055-02

Spekulum konisch, für Jungfrauen
Speculum tapered, for virgins
Spéculum conique, pour vierges
Espéculo conico, para virgenes
Specolo conico, per virgini



110 mm x 14 mm	tk 34056-01
115 mm x 17 mm	tk 34056-02

Halter
Retractor
Valve
Valva
Valve



tk 34057-01
tk 34057-02

Satz
Set
Jeu
Juego
Serie

Scheidenspekula
Vaginal specula

Spéculums vaginaux
Espéculos vaginales
Specoli vaginali

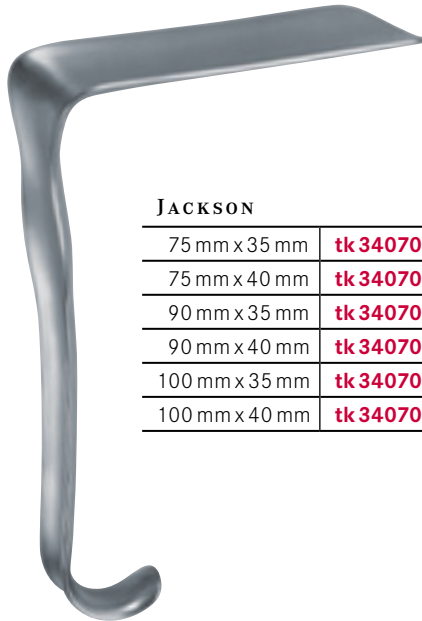

JACKSON

75 mm x 35 mm	tk 34070-10
75 mm x 40 mm	tk 34070-15
90 mm x 35 mm	tk 34070-20
90 mm x 40 mm	tk 34070-25
100 mm x 35 mm	tk 34070-30
100 mm x 40 mm	tk 34070-35



AUVARD

220 mm - 8 3/4"
80 mm x 38 mm
tk 34060-00

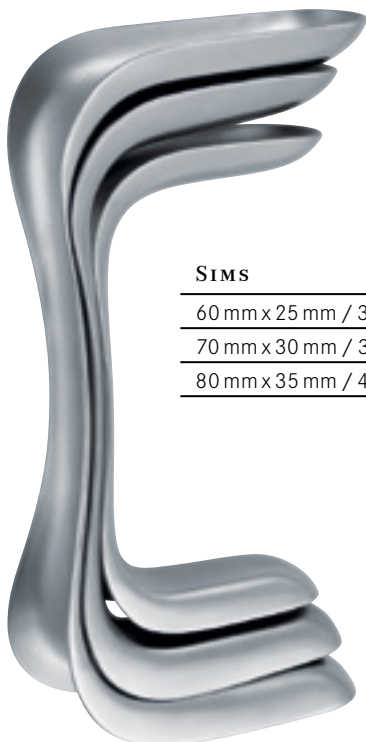

SIMS

60 mm x 25 mm / 30 mm	tk 34075-01
70 mm x 30 mm / 35 mm	tk 34075-02
80 mm x 35 mm / 40 mm	tk 34075-03

Scheidenspekula
Vaginal specula

Spéculums vaginaux
Espéculos vaginales
Specoli vaginali



KALLMORGEN

70 mm x 40 mm	tk 34072-01
90 mm x 40 mm	tk 34072-02

Spekulum
Speculum

Spéculum
Espéculo
Specolo



70 mm x 33 mm	tk 34073-01
90 mm x 33 mm	tk 34073-02

Halter
Retractor

Valve
Valva
Valve



tk 34074-01
tk 34074-02

Satz
Set

Jeu
Juego
Serie

Scheidenspekula
Vaginal specula

Spéculums vaginaux
Espéculos vaginales
Specoli vaginali



LANDAU

	290 mm - 11½"
100 mm x 28 mm	tk 34128-01
110 mm x 38 mm	tk 34128-02

BREISKY

	320 mm - 12¾"
130 mm x 20 mm	tk 34130-20
130 mm x 25 mm	tk 34130-25
130 mm x 30 mm	tk 34130-30
130 mm x 35 mm	tk 34130-35
130 mm x 40 mm	tk 34130-40

	300 mm - 12"
100 mm x 20 mm	tk 34142-20
100 mm x 25 mm	tk 34142-25
100 mm x 30 mm	tk 34142-30
100 mm x 35 mm	tk 34142-35
100 mm x 40 mm	tk 34142-40

	350 mm - 13¾"
160 mm x 40 mm	tk 34140-40
180 mm x 40 mm	tk 34140-41

Wiener Modell
Vienna pattern

Modèle Vienne
Modelo Vienna
Modello Vienna

Scheidenspekula
Vaginal specula

Spéculums vaginaux
Espéculos vaginales
Specoli vaginali



Fig. 1	Fig. 2	Fig. 3	Fig. 4	Fig. 5
80 mm x 30 mm	85 mm x 35 mm	90 mm x 40 mm	55 mm x 40 mm / 60 mm	70 mm x 45 mm / 70 mm
tk 34090-01	tk 34090-02	tk 34090-03	tk 34090-04	tk 34090-05

SCHERBACK

tk 34090-00

Satz (Fig. 1-Fig. 2) mit 400 g Gewicht (tk 34090-10)
Set (Fig. 1 - Fig. 2) with weight 400 grs. (tk 34090-10)

Jeu (Fig. 1 - Fig. 2) avec poids 400 gr. (tk 34090-10)

Juego (Fig. 1 - Fig. 2) con peso 400 gr. (tk 34090-10)

Serie (Fig. 1 - Fig. 2) con peso di 400 gr. (tk 34090-10)



400 g	tk 34090-10
600 g	tk 34090-11
800 g	tk 34090-12



tk 34090-14

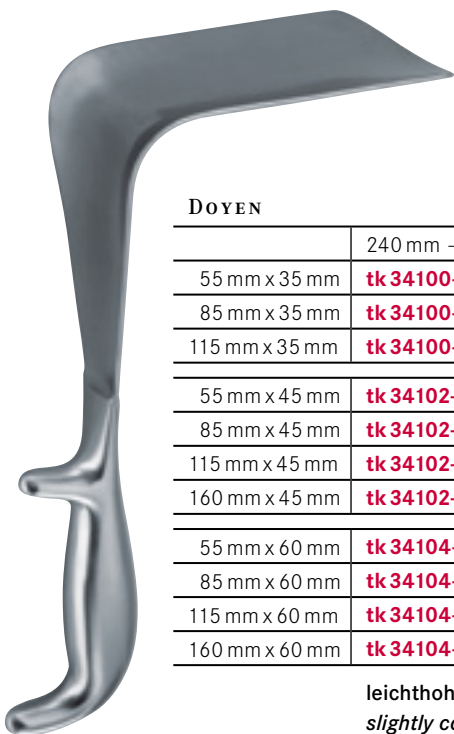

DOYEN

	240 mm - 9 1/2"
55 mm x 35 mm	tk 34100-01
85 mm x 35 mm	tk 34100-02
115 mm x 35 mm	tk 34100-03
55 mm x 45 mm	tk 34102-01
85 mm x 45 mm	tk 34102-02
115 mm x 45 mm	tk 34102-03
160 mm x 45 mm	tk 34102-04
55 mm x 60 mm	tk 34104-01
85 mm x 60 mm	tk 34104-02
115 mm x 60 mm	tk 34104-03
160 mm x 60 mm	tk 34104-04

leichthohl

slightly concave

légèrement concave

ligeramente concava

legermente concavo

Endospekula
Endospecula

Endospéculums
Endospéculos
Endospecoli



KOGAN

240 mm - 9½" | **tk 34153-24**

mit Skalensperre und Stellschraube
with scale-ratchet and fixation screw

avec crémaillère à échelle et vis à fixation
con cremallera graduada y tornillo fijación
con cremagliera graduata e vite di fissaggio



KOGAN-MODIF.

280 mm - 11"

x = 4 mm y = 8 mm | **tk 34150-01**

x = 2 mm y = 4 mm | **tk 34150-02**

Parametriumklemmen
Parametrium forceps

Pinces parametrium
Pinzas parametrium
Pinze parametrium

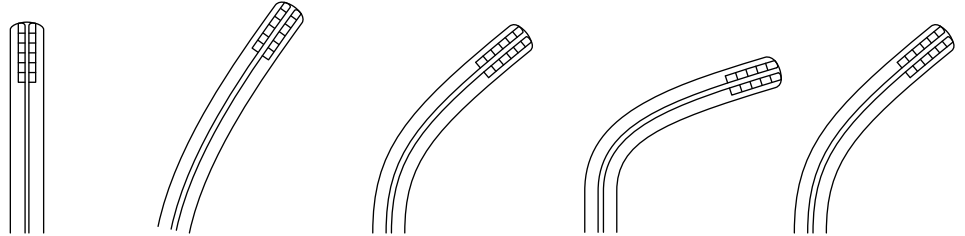
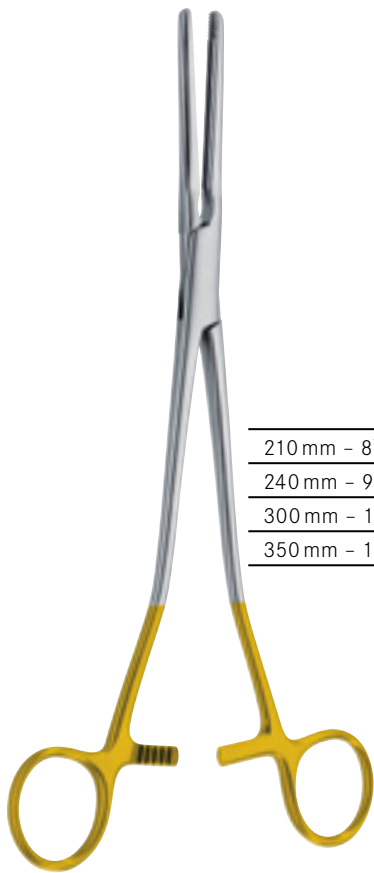

210 mm - 8 1/4"	tk 34155-21	tk 34156-21	tk 34157-21	tk 34158-21	tk 34159-21
240 mm - 9 1/2"	tk 34155-24	tk 34156-24	tk 34157-24	tk 34158-24	tk 34159-24
300 mm - 12"	tk 34155-30	tk 34156-30	tk 34157-30	tk 34158-30	tk 34159-30
350 mm - 13 3/4"	tk 34155-35	tk 34156-35	tk 34157-35	tk 34158-35	tk 34159-35

S-förmig gebogen
S-curved
coube en S
curva en S
curva a forma di S

Hysterektomieklemmen
Hysterectomy forceps

Pinces à hystérectomie
Pinzas-clamps para hysterectomia
Pinze per isterectomia

ATRAUMTK



ROGERS

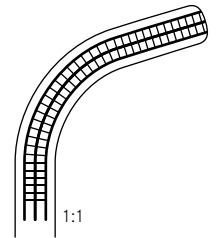
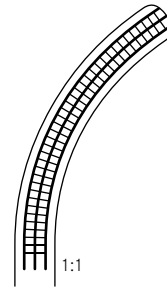
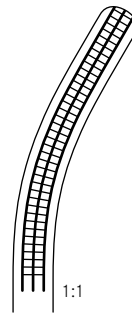
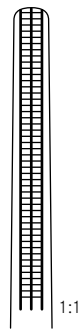

Fig. 1	Fig. 2	Fig. 3	Fig. 4
220 mm - 8 ³ / ₄ "	215 mm - 8 ¹ / ₂ "	210 mm - 8 ¹ / ₄ "	205 mm - 8"
tk 34147-01	tk 34147-02	tk 34147-03	tk 34147-04

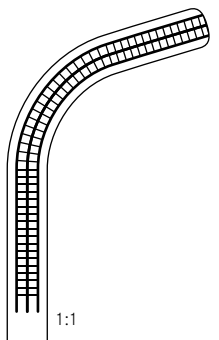
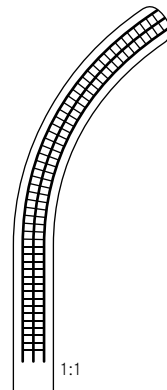
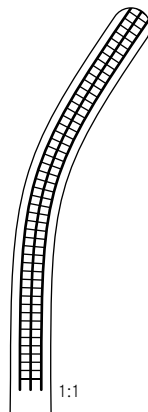
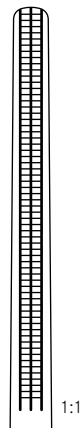

Fig. 1	Fig. 2	Fig. 3	Fig. 4
250 mm - 9 ³ / ₄ "	250 mm - 9 ³ / ₄ "	245 mm - 9 ³ / ₄ "	230 mm - 9"
tk 34148-01	tk 34148-02	tk 34148-03	tk 34148-04

Uterus-Sonden
Uterine sounds

Hystéromètres du col de l'utérus
Histerómetros uterinos
Isterometri uterini



1:2

VALLEIX

250 mm - 9¾" **tk 34197-25**

graduiert, mit Schieber
graduated, with slider
graduado, avec curseur
graduado, con cursor
graduato, con cursore



MARTIN

320 mm - 12½" **tk 34198-32** **tk 34199-32**

fest	biegsam
<i>rigid</i>	<i>malleable</i>
rigide	malléable
<i>rigido</i>	<i>maleable</i>
rigido	malleabile



SIMS

320 mm - 12½" **tk 34200-32** **tk 34201-32**

fest	biegsam
<i>rigid</i>	<i>malleable</i>
rigide	malléable
<i>rigido</i>	<i>maleable</i>
rigido	malleabile

Uterus-Dilatatoren
Uterine dilators

Dilatateurs du col de l'utérus
Dilatadores uterinos
Dilatatori uterini



HEGAR

1.0 mm Ø	tk 34250-10
1.5 mm Ø	tk 34250-15
2.0 mm Ø	tk 34250-20
2.5 mm Ø	tk 34250-25
3.0 mm Ø	tk 34250-30
3.5 mm Ø	tk 34250-35
4.0 mm Ø	tk 34250-40
4.5 mm Ø	tk 34250-45
5.0 mm Ø	tk 34250-50
5.5 mm Ø	tk 34250-55
6.0 mm Ø	tk 34250-60
6.5 mm Ø	tk 34250-65
7.0 mm Ø	tk 34250-70
7.5 mm Ø	tk 34250-75
8.0 mm Ø	tk 34250-80
8.5 mm Ø	tk 34250-85
9.0 mm Ø	tk 34250-90
9.5 mm Ø	tk 34250-95

10.0 mm Ø	tk 34251-00
10.5 mm Ø	tk 34251-05
11.0 mm Ø	tk 34251-10
11.5 mm Ø	tk 34251-15
12.0 mm Ø	tk 34251-20
12.5 mm Ø	tk 34251-25
13.0 mm Ø	tk 34251-30
13.5 mm Ø	tk 34251-35
14.0 mm Ø	tk 34251-40
14.5 mm Ø	tk 34251-45
15.0 mm Ø	tk 34251-50
15.5 mm Ø	tk 34251-55
16.0 mm Ø	tk 34251-60
16.5 mm Ø	tk 34251-65
17.0 mm Ø	tk 34251-70
17.5 mm Ø	tk 34251-75
18.0 mm Ø	tk 34251-80
18.5 mm Ø	tk 34251-85
19.0 mm Ø	tk 34251-90
19.5 mm Ø	tk 34251-95

20.0 mm Ø	tk 34252-00
21.0 mm Ø	tk 34252-10
22.0 mm Ø	tk 34252-20
23.0 mm Ø	tk 34252-30
24.0 mm Ø	tk 34252-40
25.0 mm Ø	tk 34252-50
26.0 mm Ø	tk 34252-60
27.0 mm Ø	tk 34252-70
28.0 mm Ø	tk 34252-80
29.0 mm Ø	tk 34252-90
30.0 mm Ø	tk 34253-00

HEGAR

4 mm - 17 mm Ø	14	tk 34260-14
1 mm - 26 mm Ø	26	tk 34260-26

Stück per Satz	Satz, ohne Metalletui
<i>Pieces per set</i>	<i>Set, without metal case</i>
Pièces per jeu	Jeu, sans boîte en métal
<i>Piezas para juego</i>	<i>Juego, sin caja de metal</i>
Pezzi per serie	Serie, senza astuccio metallico

Uterus-Dilatatoren
Uterine dilators

Dilatateurs du col de l'utérus
Dilatadores uterinos
Dilatatori uterini

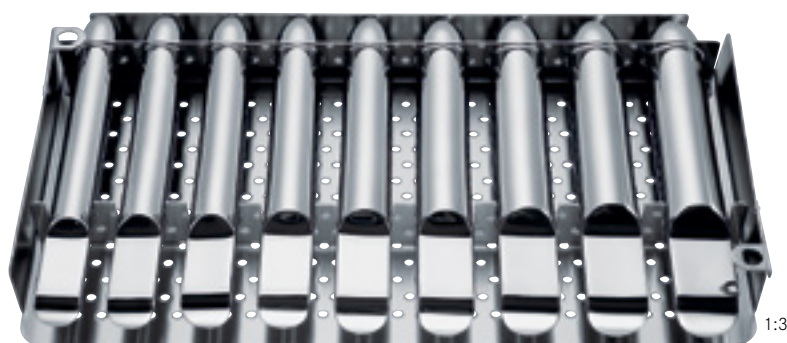

HEGAR

4 mm - 17 mm Ø	14	tk 34261-14	tk 34261-15
1 mm - 26 mm Ø	26	tk 34261-26	tk 34261-27

Stück per Satz
Pieces per set

Satz, in Metalletui
Set, in metal case

Metalletui mit 2 Einlegeböden
metal case with 2 shelves

Pièces per jeu
Piezas para juego

Jeu, en boîte de métal
Juego, en caja de metal

boîte de métal avec 2 étagères
caja de metal con 2 estantes

Pezzi per serie

Serie, con astuccio metallico

astuccio metallica con 2 scaffali

Uterus-Dilatatoren
Uterine dilators

Dilatateurs du col de l'utérus
Dilatadores uterinos
Dilatatori uterini



HEGAR

1 / 2 mm Ø	tk 34262-02
3 / 4 mm Ø	tk 34262-04
5 / 6 mm Ø	tk 34262-06
7 / 8 mm Ø	tk 34262-08
9 / 10 mm Ø	tk 34262-10
11 / 12 mm Ø	tk 34262-12
13 / 14 mm Ø	tk 34262-14
15 / 16 mm Ø	tk 34262-16
17 / 18 mm Ø	tk 34262-18
19 / 20 mm Ø	tk 34262-20
21 / 22 mm Ø	tk 34262-22
23 / 24 mm Ø	tk 34262-24
25 / 26 mm Ø	tk 34262-26

HEGAR

3 / 4 mm - 17 / 18 mm Ø	8	tk 34265-05
1 / 2 mm - 25 / 26 mm Ø	13	tk 34265-06

Stück per Satz Satz, allein
Pieces per set *Set, only*
Pièces per jeu Jeu, seul
Piezas para juego *Juego, solo*
Pezzi per serie Serie, solo



1:3



1:3

HEGAR

3 / 4 mm - 17 / 18 mm Ø	8	tk 34265-00	tk 34265-08
1 / 2 mm - 25 / 26 mm Ø	13		tk 34265-13

Stück per Satz Satz in Stoffrolltasche
Pieces per set *Set in canvas roll*
Pièces per jeu Jeu en poche de textile
Piezas para juego *Juego en bolsa de tela*
Pezzi per serie Serie in astuccio di tela

Satz, in Metalletui
Set, in metal case
Jeu, en boîte de métal
Juego, en caja de metal
Serie, in astuccio metallico

Uterus-Dilatatoren und -Depressoren
Uterine dilators and depressors

Dilatateurs du col de l'utérus et dépresseurs utérins
Dilatadores uterinos y depresores uterinos
Dilatatori uterini e depressori uterini



HANK		
Fig. 09/10	4.5 / 5.0 mm Ø	tk 34280-10
Fig. 11/12	5.5 / 6.0 mm Ø	tk 34280-12
Fig. 13/14	6.5 / 7.0 mm Ø	tk 34280-14
Fig. 15/16	7.5 / 8.0 mm Ø	tk 34280-16
Fig. 17/18	8.5 / 9.0 mm Ø	tk 34280-18
Fig. 19/20	9.5 / 10.0 mm Ø	tk 34280-20

HANK		
4.5 / 5 mm - 9.5 / 10 mm Ø	6	tk 34281-80
Stück per Satz	Satz, allein	
Pieces per set	Set, only	
Pièces per jeu	Jeu, seul	
Piezas para juego	Juego, solo	
Pezzi per serie	Serie, solo	



1:3

HANK		
4.5 / 5 mm - 9.5 / 10 mm Ø	6	tk 34281-82

Stück per Satz Satz, in Stoffrolle
Pieces per set Set, in canvas roll
Pièces per jeu Jeu, en poche de textile
Piezas para juego Juego, en bolsa de tela
Pezzi per serie Serie, in astuccio di tela



BRAUN
280 mm - 11 "
tk 34295-26

1:3

Hakenzangen
Tenaculum forceps

Pinces pour l'abaissement du col de l'utérus
Pinzas para coger el cuello del útero
Pinze per abbassare il collo dell'utero



**STAUDE-
MOORE**

170 mm - 6¾"

tk 34302-17



BARRETT

180 mm - 7"

tk 34305-18



SKENE

240 mm - 9½"

tk 34301-24



BRAUN

250 mm - 9¾"

tk 34303-25

Hakenzangen
Tenaculum forceps

Pinces pour l'abaissement du col de l'utérus
Pinzas para coger el cuello del útero
Pinze per abbassare il collo dell'utero



POZZI

255 mm - 10"

tk 34311-26



SCHROEDER

250 mm - 9¾"

tk 34310-25

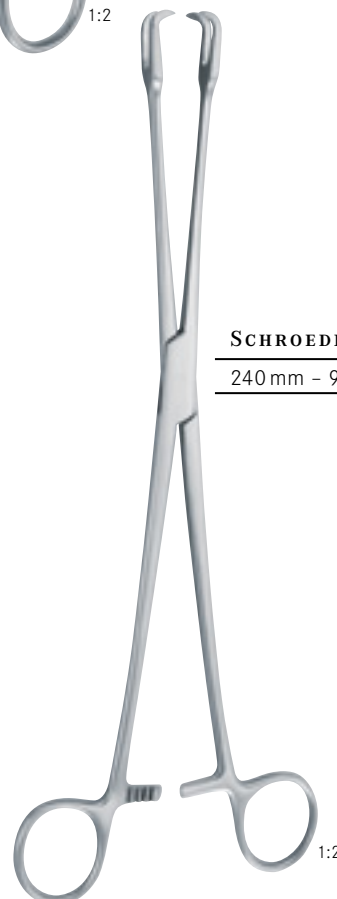

SCHROEDER

240 mm - 9½"



1:2

tk 34314-24



1:2

tk 34315-24

Hakenzangen
Tenaculum forceps

Pinces pour l'abaissement du col de l'utérus
Pinzas para coger el cuello del útero
Pinze per abbassare il collo dell'utero



1:2

DUPLAY

280 mm - 11 "

tk 34320-28



1:2

IOWA

260 mm - 10 1/4 "

tk 34329-26



1:2

BEACHAM

260 mm - 10 1/4 "

tk 34322-26

Amniotom
Amniotome
Amniotomo
Amniotomo
Amniotomo

Hakenzangen
Tenaculum forceps

Pinces pour l'abaissement du col de l'utérus
Pinzas para coger el cuello del útero
Pinze per abbassare il collo dell'utero

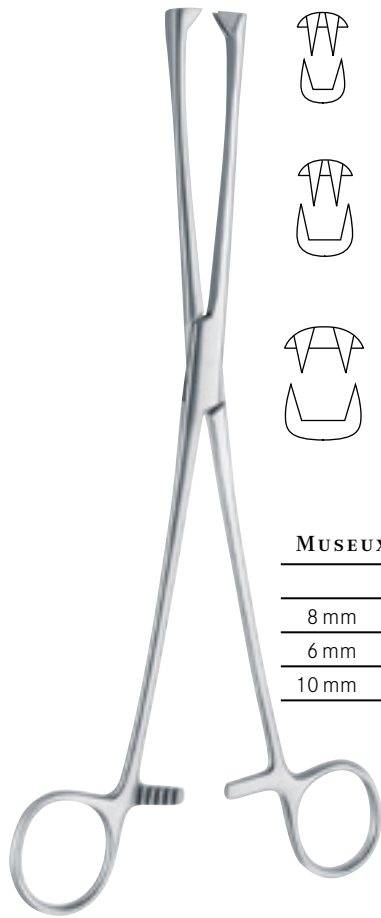

MUSEUX

	240 mm - 9 1/2"	240 mm - 9 1/2"
8 mm	tk 34352-24	tk 34357-24
6 mm	tk 34353-24	tk 34358-24
10 mm	tk 34351-24	tk 34356-24



TEALE

230 mm - 9"
tk 34328-23

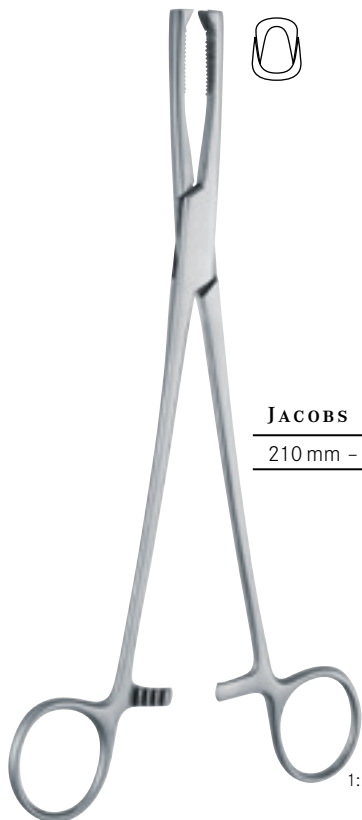

JACOBS

210 mm - 8 1/4"	tk 34360-21	tk 34361-21
-----------------	--------------------	--------------------

1:2

1:2

Hakenzangen
Tenaculum forceps

Pinces pour abaissement du col de l'utérus
Pinzas para coger el cuello del útero
Pinze per abbassare il collo dell'utero



PRATT

260 mm - 10 $\frac{1}{4}$ " **tk 34364-26**



CZERNY

205 mm - 8" **tk 34366-21**

Uterus-Polypenzangen
Uterine polypus forceps

Pinces à polypes utérins
Pinzas para pólipos uterinos
 Pinze per polipi uterini

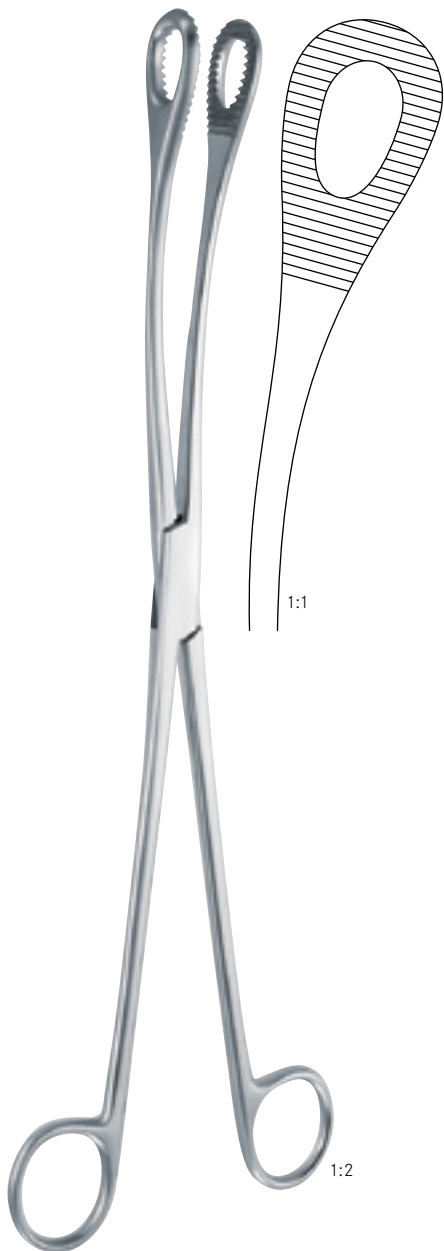

KELLY

320 mm - 12½" **tk 34380-32**

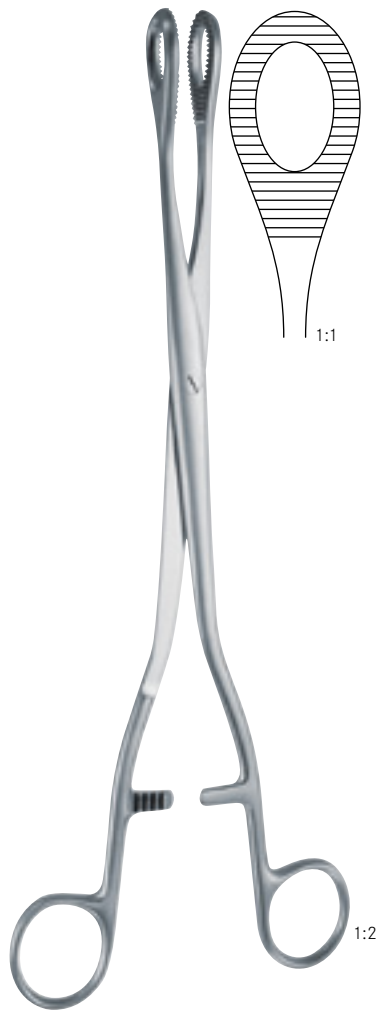

NOTO

270 mm - 10¾" **tk 34375-27**

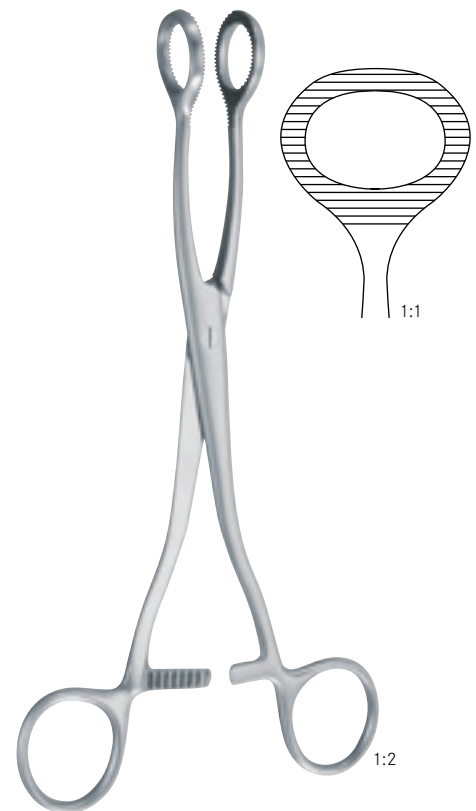

DOYEN

200 mm - 8" **tk 34370-20**

Uterusfazzangen
Uterine seizing forceps

Pincés hystérolabes
Histerólabos
Pinze isterolabi



DARTIGUES

270 mm - 10³/₄" **tk 34394-27**



SOMER

230 mm - 9" **tk 34393-23**



COLLIN

250 mm - 9³/₄" **tk 34395-25**

Myom-Instrumente
Myoma instruments

Instruments pour myomes
Instrumentos para fibroma
Strumenti per miomi

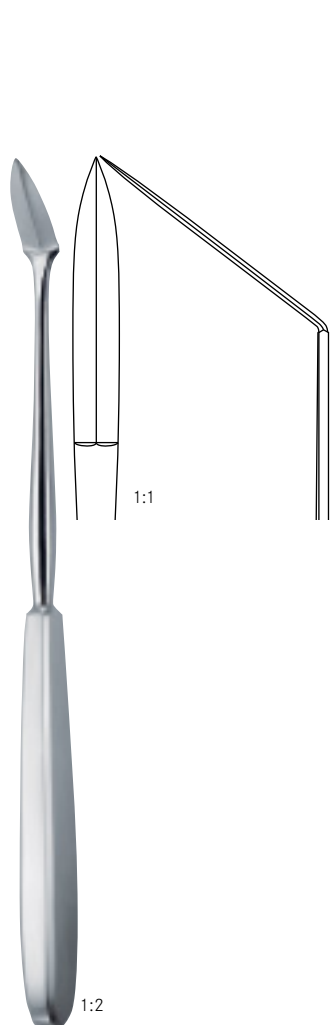
**AYRE**

230 mm - 9"

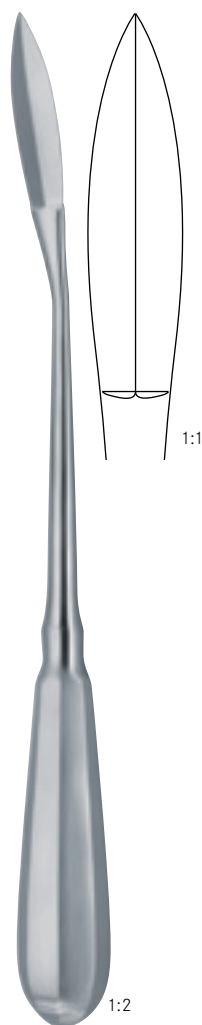
tk 34396-23**SEGOND**270 mm - 10³/₄"**tk 34397-27****DOYEN**170 mm - 6³/₄"**tk 34399-02**

Fistelhaken
Fistula hooks

Crochets pour fistules
Ganchos para fístulas
Uncini per fistole



SIMON		
	Fig. 1	Fig. 2
220 mm - 8 ³ / ₄ "	tk 34398-01	tk 34398-02



EMMET		
	Fig. 1	Fig. 2
220 mm - 8 ³ / ₄ "	tk 16958-01	tk 16958-02
	Fig. 3	Fig. 4
220 mm - 8 ³ / ₄ "	tk 16958-03	tk 16958-04
	Fig. 5	
220 mm - 8 ³ / ₄ "	tk 16958-05	

Probeexzisionszangen
Cervical biopsy and specimen forceps

Pinces emporte-pièces à biopsie
Pinzas saca-bocados para biopsia
Pinze taglianti per biopsia



SCHUBERT

210 mm - 8½"	tk 34400-21
280 mm - 11"	tk 34400-29



FAURE

210 mm - 8½"	tk 34410-24
--------------	--------------------



SCHUBERT

260 mm - 10¼"	tk 34440-26
---------------	--------------------

Probeexzisionszangen
Cervical biopsy and specimen forceps

Pinces emporte-pièces à biopsie
Pinzas saca-bocados para biopsia
Pinze taglianti per biopsia



GELHORN

230 mm - 9"

tk 34402-23



THOMS-GAYLOR

220 mm - 8³/₄"

tk 34420-22

240 mm - 9¹/₂"

tk 34420-24

Probeexzisionszangen
Cervical biopsy and specimen forceps

Pinces emporte-pièces à biopsie
Pinzas saca-bocados para biopsia
Pinze taglianti per biopsia

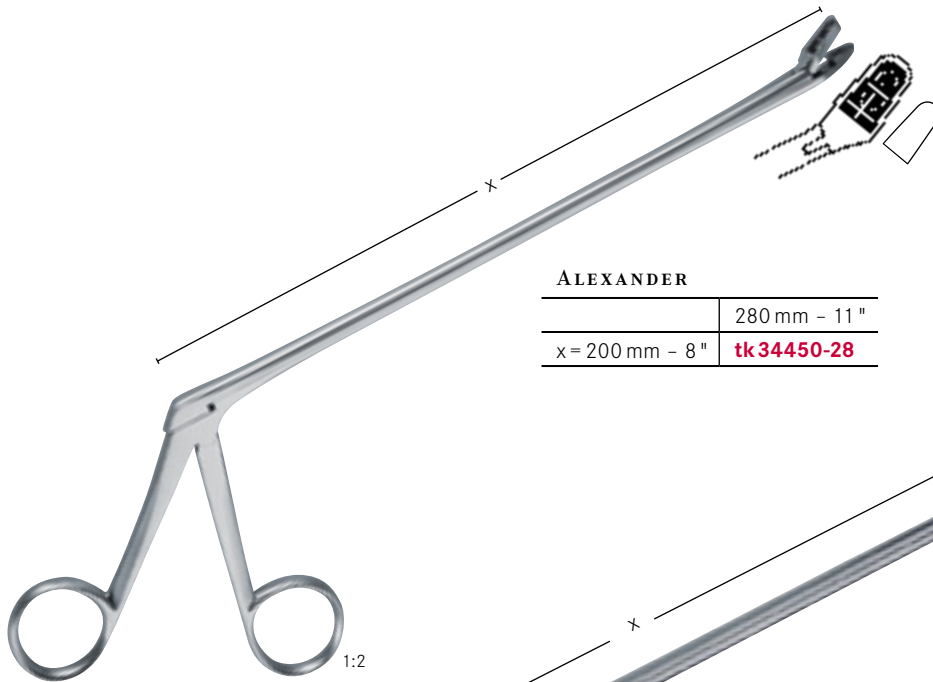

ALEXANDER

	280 mm - 11"
x = 200 mm - 8"	tk 34450-28

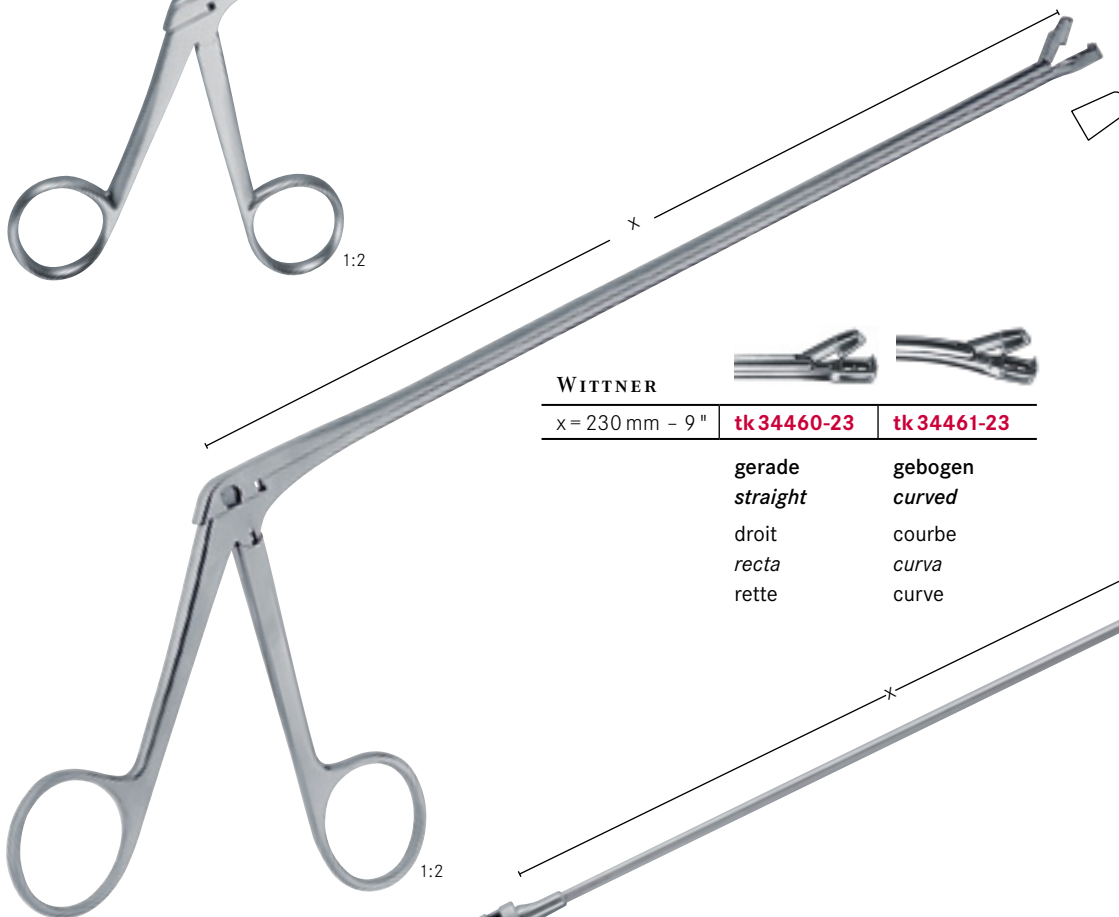

WITTNER

x = 230 mm - 9"	tk 34460-23	tk 34461-23
-----------------	-------------	-------------

gerade	gebogen
straight	curved
droit	courbe
recta	curva
rette	curve

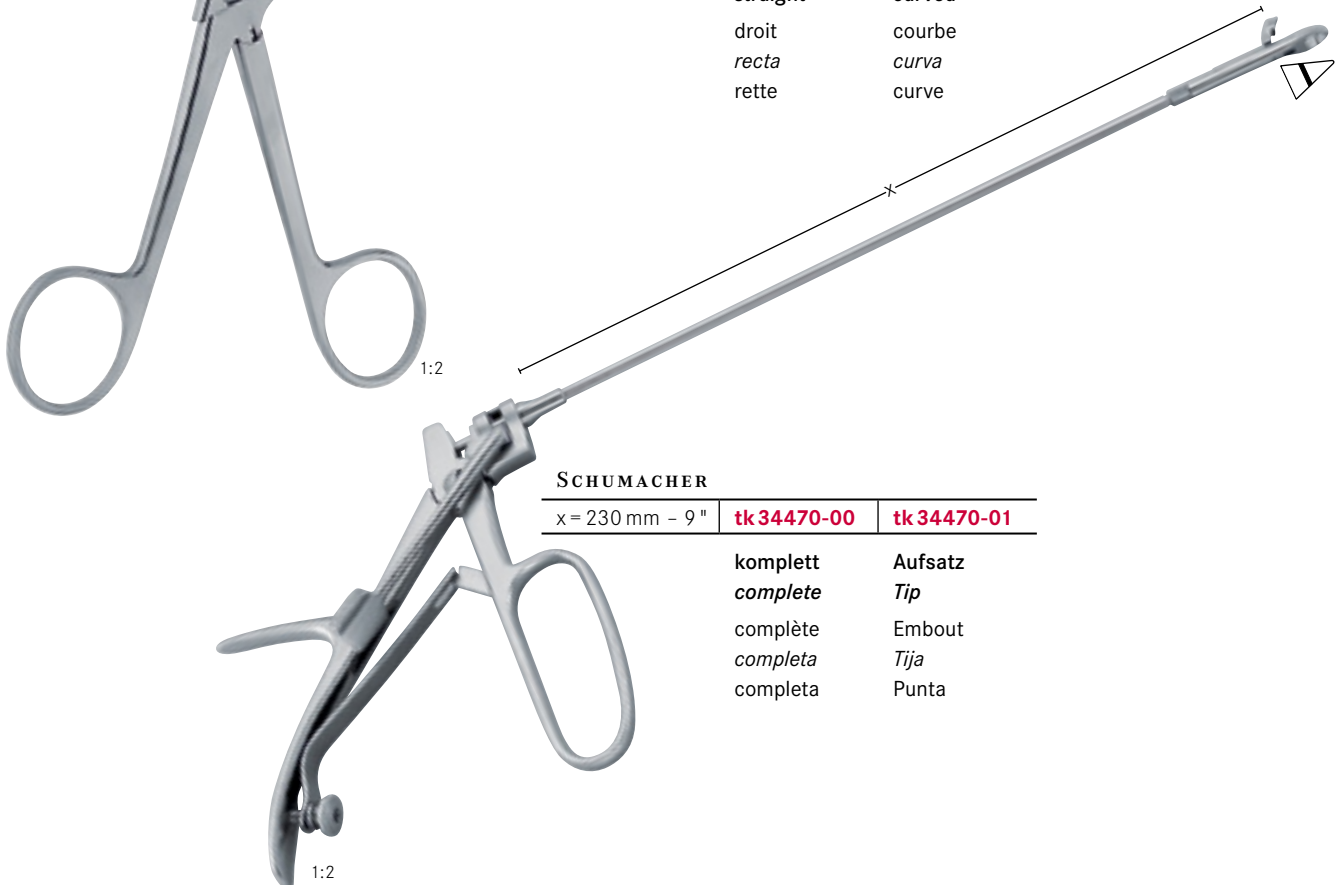

SCHUMACHER

x = 230 mm - 9"	tk 34470-00	tk 34470-01
-----------------	-------------	-------------

komplett	Aufsatz
complete	Tip
complète	Embout
completa	Tija
completa	Punta

Probeexzisionszangen
Cervical biopsy and specimen forceps

Pinces emporte-pièces à biopsie
Pinzas saca-bocados para biopsia
Pinze taglianti per biopsia



VAN DOREN

240 mm - 9½"

tk 34470-25

1:2

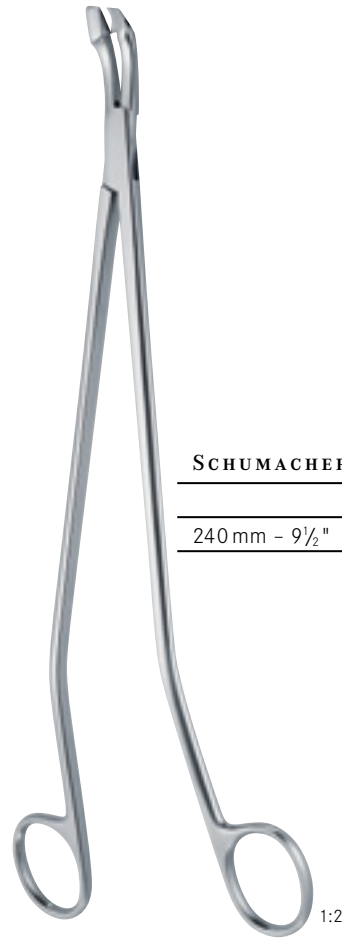

SCHUMACHER

1:1

1:1

Fig. 1

Fig. 2

240 mm - 9½"

tk 34473-01

tk 34473-02

1:2

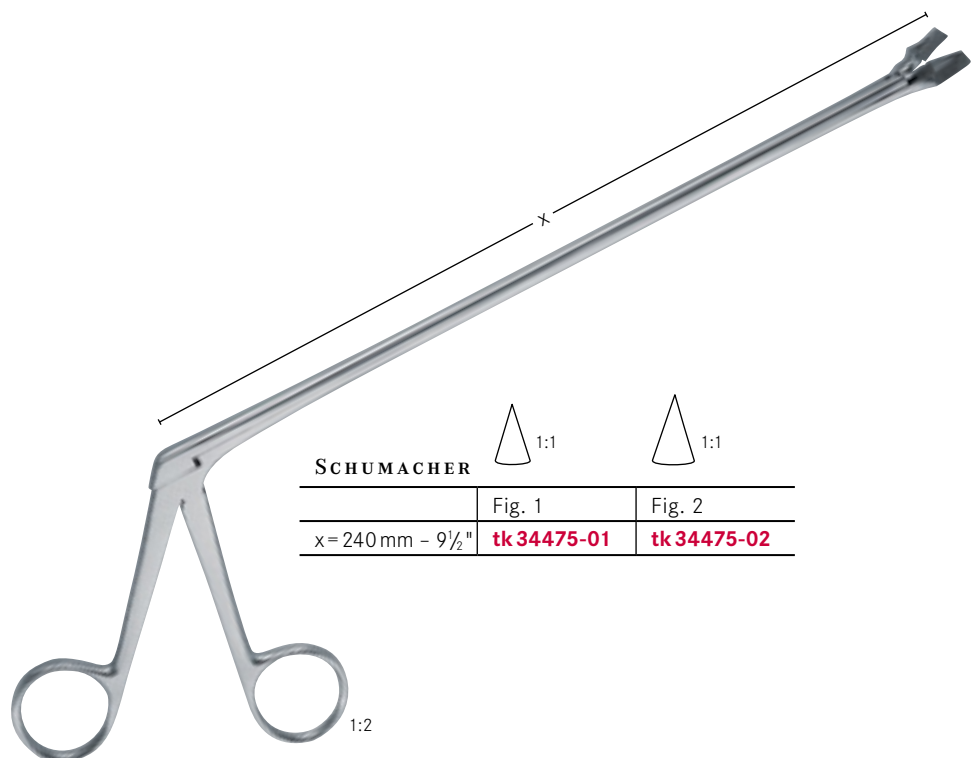

SCHUMACHER

1:1

1:1

Fig. 1

Fig. 2

x = 240 mm - 9½"

tk 34475-01

tk 34475-02

1:2

Probeexzisionszangen
Cervical biopsy and specimen forceps

Pinces emporte-pièces à biopsie
Pinzas saca-bocados para biopsia
Pinze taglianti per biopsia

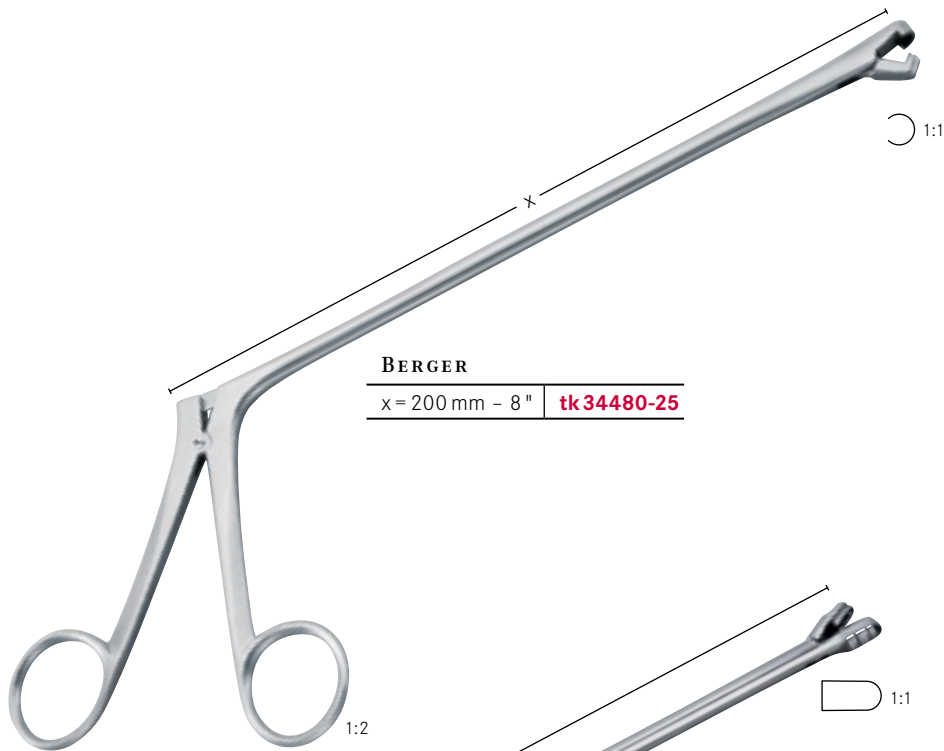

BERGER

x = 200 mm - 8" **tk 34480-25**

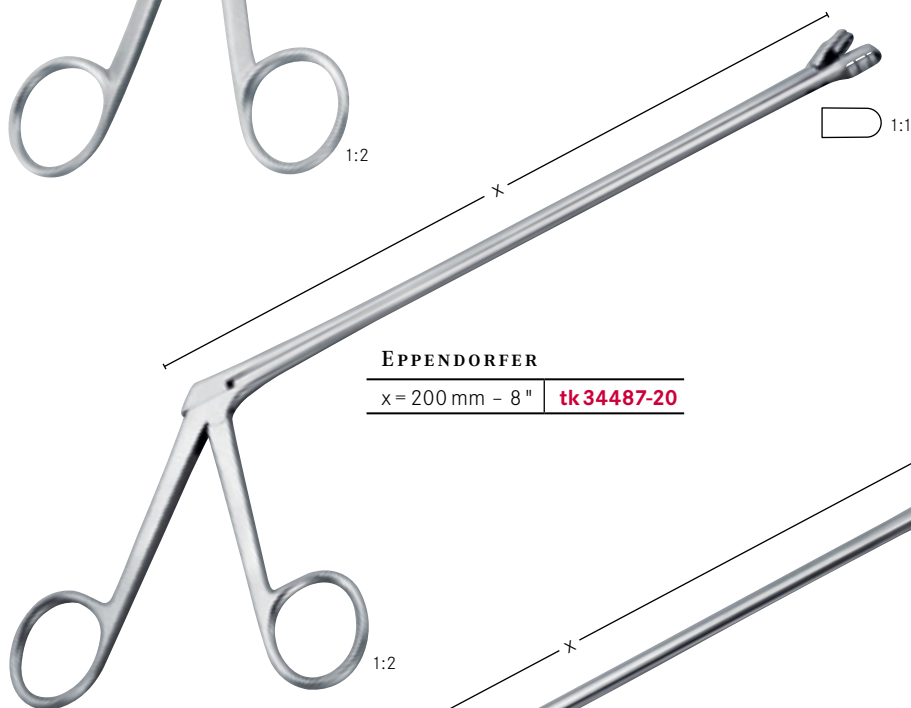

EPPENDORFER

x = 200 mm - 8" **tk 34487-20**



KEVORKIAN

x = 245 mm - 9¾" **tk 34489-24**

Probeexzisionszangen
Cervical biopsy and specimen forceps

Pinces emporte-pièces à biopsie
Pinzas saca-bocados para biopsia
Pinze taglianti per biopsia

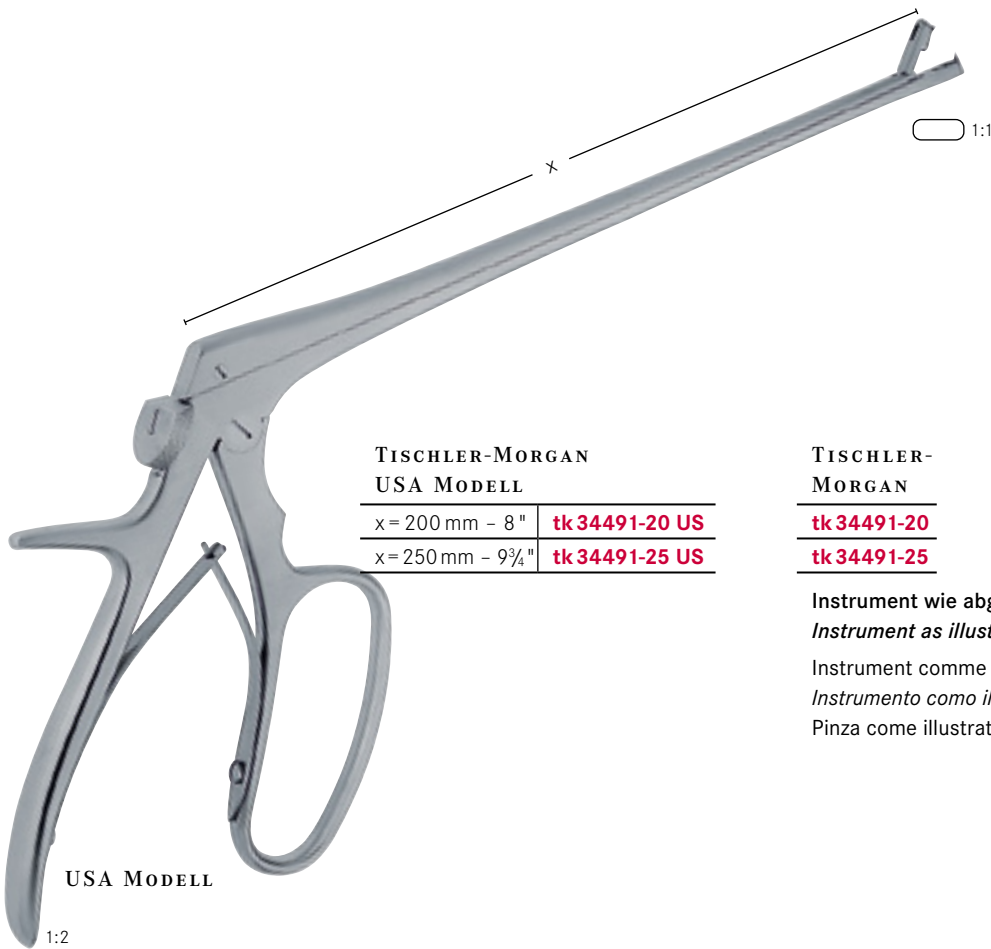

**TISCHLER-MORGAN
USA MODELL**

x = 200 mm - 8" **tk 34491-20 US**

x = 250 mm - 9¾" **tk 34491-25 US**

**TISCHLER-
MORGAN**

tk 34491-20

tk 34491-25

Instrument wie abgebildet, jedoch ohne Feststellschraube.
Instrument as illustrated, but without locking screw.

Instrument comme illustré, mais sans vis de fixation.

Instrumento como ilustrado, pero sin tornillo de fijación.

Pinza come illustrata però senza vite di fissaggio.

Probeexzisionszangen
Cervical biopsy and specimen forceps

Pinces emporte-pièces à biopsie
Pinzas saca-bocados para biopsia
Pinze taglianti per biopsia

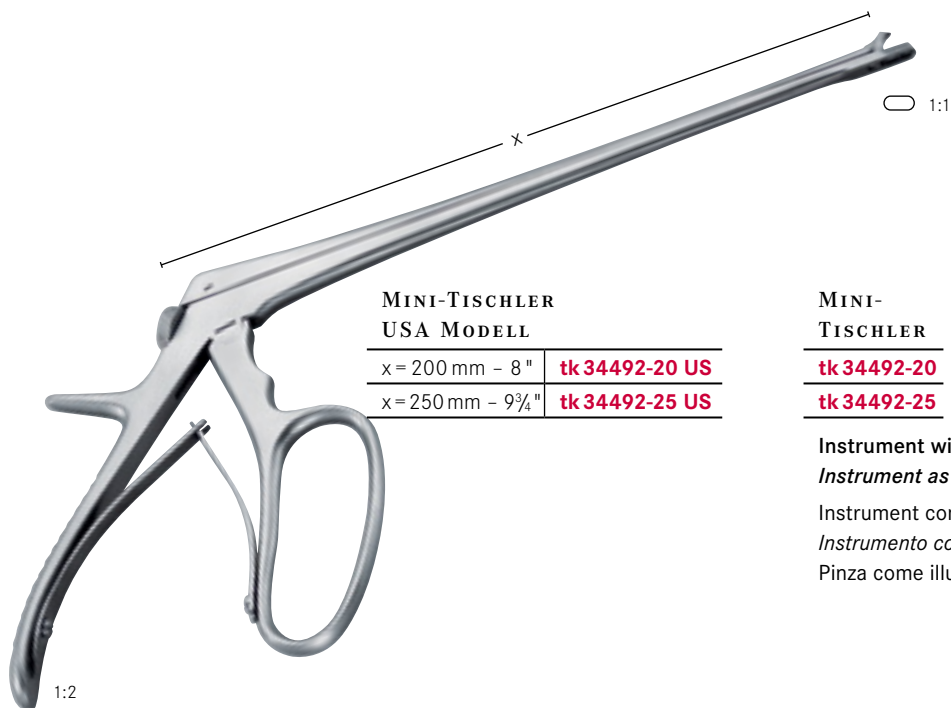

**MINI-TISCHLER
USA MODELL**

x = 200 mm - 8"	tk 34492-20 US
x = 250 mm - 9¾"	tk 34492-25 US

**MINI-
TISCHLER**

tk 34492-20
tk 34492-25

Instrument wie abgebildet, jedoch ohne Feststellschraube.
Instrument as illustrated, but without locking screw.

Instrument comme illustré, mais sans vis de fixation.
Instrumento como ilustrado, pero sin tornillo de fijación.
Pinza come illustrata però senza vite di fissaggio.

Probeexzisionszangen
Cervical biopsy and specimen forceps

Pinces emporte-pièces à biopsie
Pinzas saca-bocados para biopsia
Pinze taglianti per biopsia



UNI-TISCHLER

3 x 7 mm

tk 34492-01

gerade, Aufsatz allein
straight, Tip only
droit, mors seul
recta, boca sola
retta, punta sola

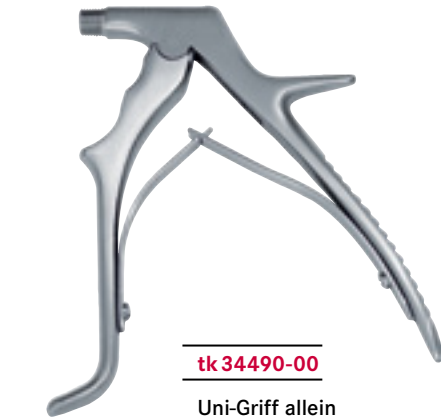

tk 34490-00

Uni-Griff allein
Handle only
Poignee seule
Mango solo
Manico solo



UNI-TISCHLER

3 x 7 mm

tk 34492-02

aufwärts, Aufsatz allein
up, Tip only
haut, mors seul
arriba, boca sola
in alto, punta sola



UNI-TISCHLER

3 x 7 mm

tk 34492-03

abwärts, Aufsatz allein
down, Tip only
bas, mors seul
abajo, boca sola
in basso, punta sola



UNI-TOWNSEND

2.3 x 4 mm

tk 34492-04

gerade, Aufsatz allein
straight, Tip only
droit, mors seul
recta, boca sola
retta, punta sola



UNI-TOWNSEND

2.3 x 4 mm

tk 34492-05

aufwärts, Aufsatz allein
up, Tip only
haut, mors seul
arriba, boca sola
in alto, punta sola



tk 34491-00

Uni-Griff allein mit Ring
Handle only
Poignee seule
Mango solo
Manico solo



UNI-TOWNSEND

2.3 x 4 mm

tk 34492-06

abwärts, Aufsatz allein
down, Tip only
bas, mors seul
abajo, boca sola
in basso, punta sola



UNI-KEVORKIAN

3 x 9 mm

tk 34492-07

Aufsatz allein
Tip only
Mors seul
Boca sola
Punta sola



UNI-OVAL

3 x 5 mm

tk 34492-08

Aufsatz allein
Tip only
Mors seul
Boca sola
Punta sola



UNI-BURKE

3 x 5 mm

tk 34492-09

Aufsatz allein
Tip only
Mors seul
Boca sola
Punta sola

Biopsieküretten
Biopsy curettes

Curettes pour biopsie
Curetas para biopsía
Curette per biopsia



RANDALL

	4 mm Ø
240 mm - 9½"	tk 34800-24



KEVORKIAN

300 mm - 12"	tk 34810-30	tk 34813-30
--------------	--------------------	--------------------

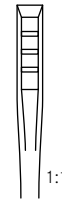

fest, ohne Korb
rigid, without basket
rigide, sans panier
rigida, sin cesta
rigida, senza cestino

fest, mit Korb
rigid, with basket
rigide, avec panier
rigida, con cesta
rigida, con cestino

tk 34811-30

tk 34812-30

biegsam, ohne Korb
malleable, without basket
malléable, sans panier
malleable, sin cesta
flessibile, senza cestino

biegsam, mit Korb
malleable, with basket
malléable, avec panier
malleable, con cesta
flessibile, con cestino

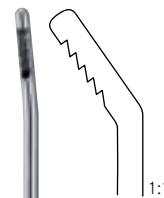

NOVAK

	4 mm Ø
230 mm - 9"	tk 34805-23

MINI-NOVAK

	235 mm - 9¼"
1 mm Ø	tk 34807-23
2 mm Ø	tk 34808-23
3 mm Ø	tk 34809-23

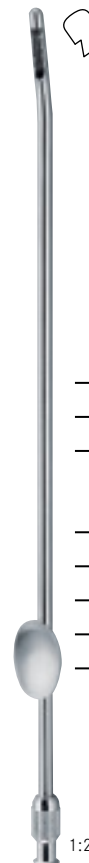

Absaugküretten
Aspirating curettes

Curettes d'aspiration
Curetas de aspiración
Curette per aspirazione

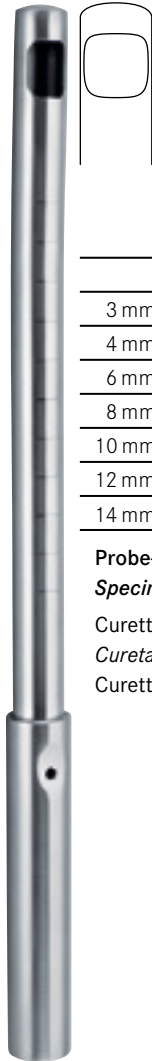

	200 mm - 11½"
3 mm Ø	tk 35530-03
4 mm Ø	tk 35530-04
6 mm Ø	tk 35530-06
8 mm Ø	tk 35530-08
10 mm Ø	tk 35530-10
12 mm Ø	tk 35530-12
14 mm Ø	tk 35530-14

Probe- und Absaugkürette

Specimen and aspirating curette

Curette à biopsies et d'aspiration

Cureta de biopsia y de aspiración

Curette per biopsia ed per aspirazione



120 mm - 4¾"	tk 35530-50
--------------	--------------------

Kupplungsstück

Coupling piece

Pièce d'accouplement

Pieza de conexión

Pezzo di connessione

Salpingograph
Salpingograph

Salpingographe
Salpingógrafo
Salpingografo

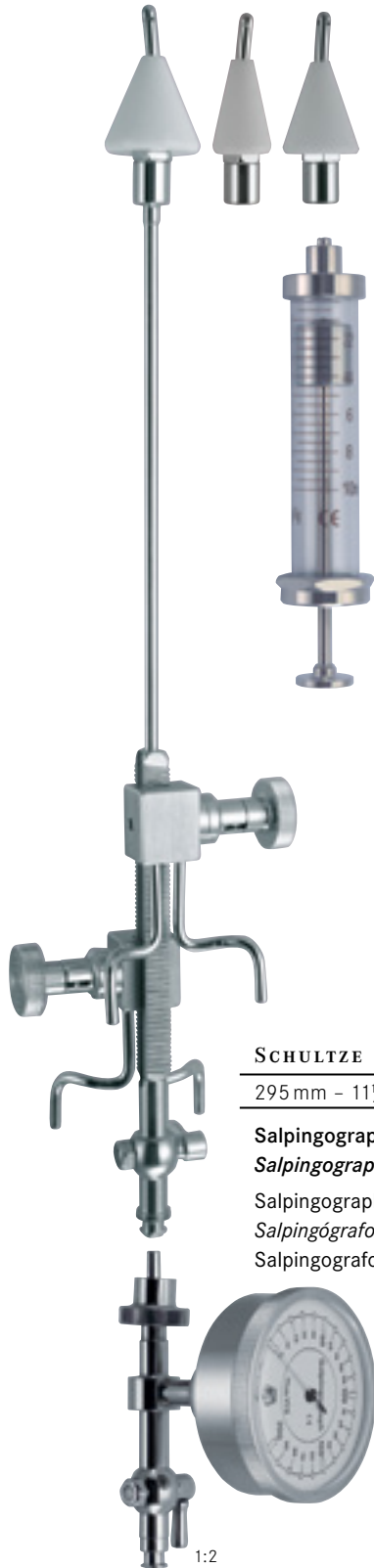

SCHULTZE

295 mm - 11½" **tk 34880-00**

Salpingograph, komplett im Holzetui
Salpingograph, complete in wooden case
Salpingographe, complet en etui de bois
Salpingógrafo, completa en caja de madera
Salpingografo, completo in astuccio di legno

1:2

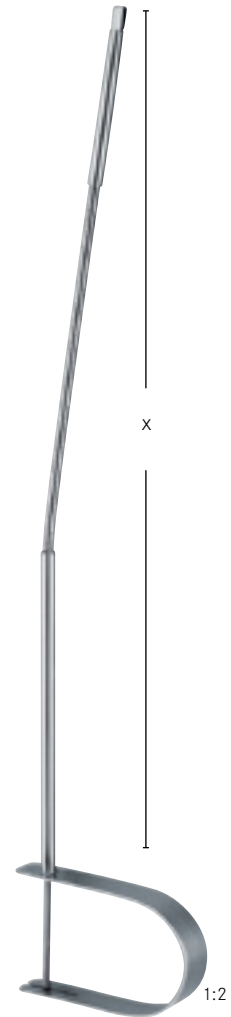

1:2

	4 mm Ø
x = 230 mm - 9"	tk 34872-00

Zange zum Entfernen von Spiralen
Forceps for I.U.D. removings

Pince pour enlever des stérilets
Pinza para remover la espiral de esterilidad
Pinza per distaccare la spirale

Uterusküretten
Uterine curettes

Curettes utérines
Curetas uterinas
Curette uterine

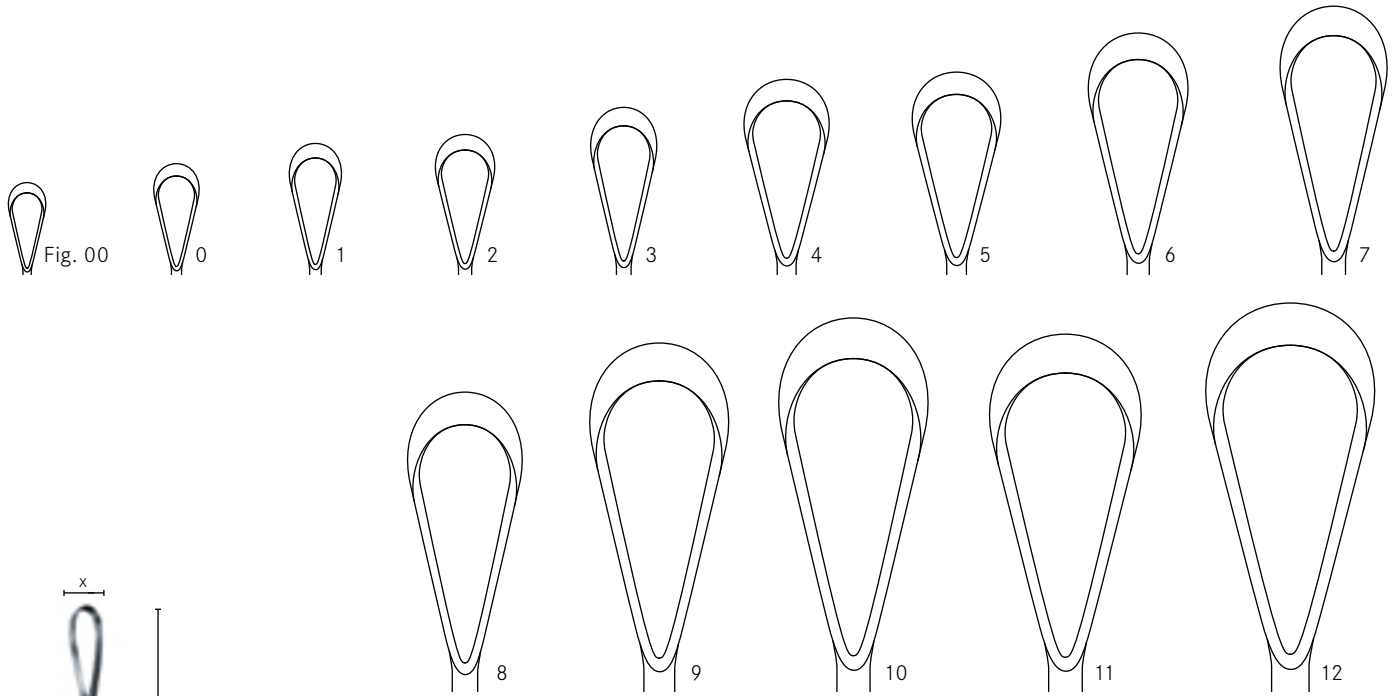

scharf, biegsam
sharp, malleable

tranchante, malléable
cortante, maleable
tagliente, flessibile

stumpf, biegsam
blunt, malleable

mousse, malléable
roma, maleable
smussa, flessibile

scharf, fest
sharp, rigid

tranchante, rigide
cortante, rigida
tagliente, rigida

stumpf, fest
blunt, rigid

mousse, rigida
roma, rigida
smussa, rigida

RECAMIER

y=260mm-10¼"	Fig.	x=mm				
	00	5	tk 35000-20	tk 35001-20	tk 35002-20	tk 35003-20
	0	6	tk 35000-00	tk 35001-00	tk 35002-00	tk 35003-00
	1	7	tk 35000-01	tk 35001-01	tk 35002-01	tk 35003-01
	2	8	tk 35000-02	tk 35001-02	tk 35002-02	tk 35003-02
	3	9	tk 35000-03	tk 35001-03	tk 35002-03	tk 35003-03
	4	11	tk 35000-04	tk 35001-04	tk 35002-04	tk 35003-04
	5	12	tk 35000-05	tk 35001-05	tk 35002-05	tk 35003-05
	6	14	tk 35000-06	tk 35001-06	tk 35002-06	tk 35003-06
	7	15	tk 35000-07	tk 35001-07	tk 35002-07	tk 35003-07
	8	16	tk 35000-08	tk 35001-08	tk 35002-08	tk 35003-08
	9	19	tk 35000-09	tk 35001-09	tk 35002-09	tk 35003-09
	10	20	tk 35000-10	tk 35001-10	tk 35002-10	tk 35003-10
	11	21	tk 35000-11	tk 35001-11	tk 35002-11	tk 35003-11
	12	23	tk 35000-12	tk 35001-12	tk 35002-12	tk 35003-12

y=310mm-12¼"	Fig.	mm				
	00	5	tk 35004-20	tk 35005-20	tk 35006-20	tk 35007-20
	0	6	tk 35004-00	tk 35005-00	tk 35006-00	tk 35007-00
	1	7	tk 35004-01	tk 35005-01	tk 35006-01	tk 35007-01
	2	8	tk 35004-02	tk 35005-02	tk 35006-02	tk 35007-02
	3	9	tk 35004-03	tk 35005-03	tk 35006-03	tk 35007-03
	4	11	tk 35004-04	tk 35005-04	tk 35006-04	tk 35007-04
	5	12	tk 35004-05	tk 35005-05	tk 35006-05	tk 35007-05
	6	14	tk 35004-06	tk 35005-06	tk 35006-06	tk 35007-06
	7	15	tk 35004-07	tk 35005-07	tk 35006-07	tk 35007-07
	8	16	tk 35004-08	tk 35005-08	tk 35006-08	tk 35007-08
	9	19	tk 35004-09	tk 35005-09	tk 35006-09	tk 35007-09
	10	20	tk 35004-10	tk 35005-10	tk 35006-10	tk 35007-10
	11	21	tk 35004-11	tk 35005-11	tk 35006-11	tk 35007-11
	12	23	tk 35004-12	tk 35005-12	tk 35006-12	tk 35007-12



Uterusküretten
Uterine curettes

Curettes utérines
Curetas uterinas
 Curette uterine

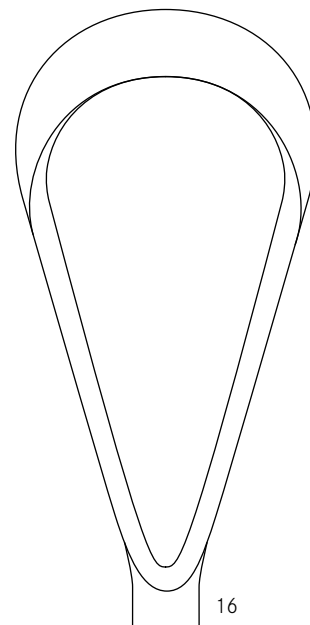
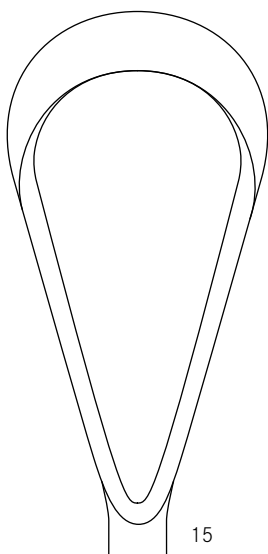
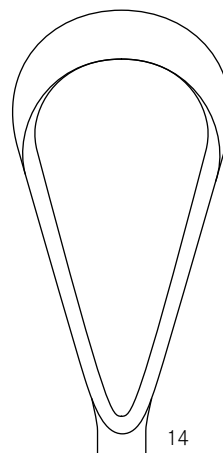
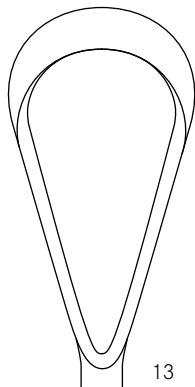

scharf, biegsam
sharp, malleable

tranchante, malléable
cortante, maleable
 tagliente, flessibile

stumpf, biegsam
blunt, malleable

mousse, malléable
roma, maleable
 smussa, flessibile

scharf, fest
sharp, rigid

tranchante, rigide
cortante, rigida
 tagliente, rigida

stumpf, fest
blunt, rigid

mousse, rigid
roma, rigida
 smussa, rigida

RECAMIER

y=340mm-13½"	Fig.	x=mm				
	13	25	tk 35004-13	tk 35005-13	tk 35006-13	tk 35007-13
	14	30	tk 35004-14	tk 35005-14	tk 35006-14	tk 35007-14
	15	35	tk 35004-15	tk 35005-15	tk 35006-15	tk 35007-15
	16	40	tk 35004-16	tk 35005-16	tk 35006-16	tk 35007-16

Uterusküretten | Currettes utérines
 Uterine curettes | Curetas uterinas
 Curette uterine

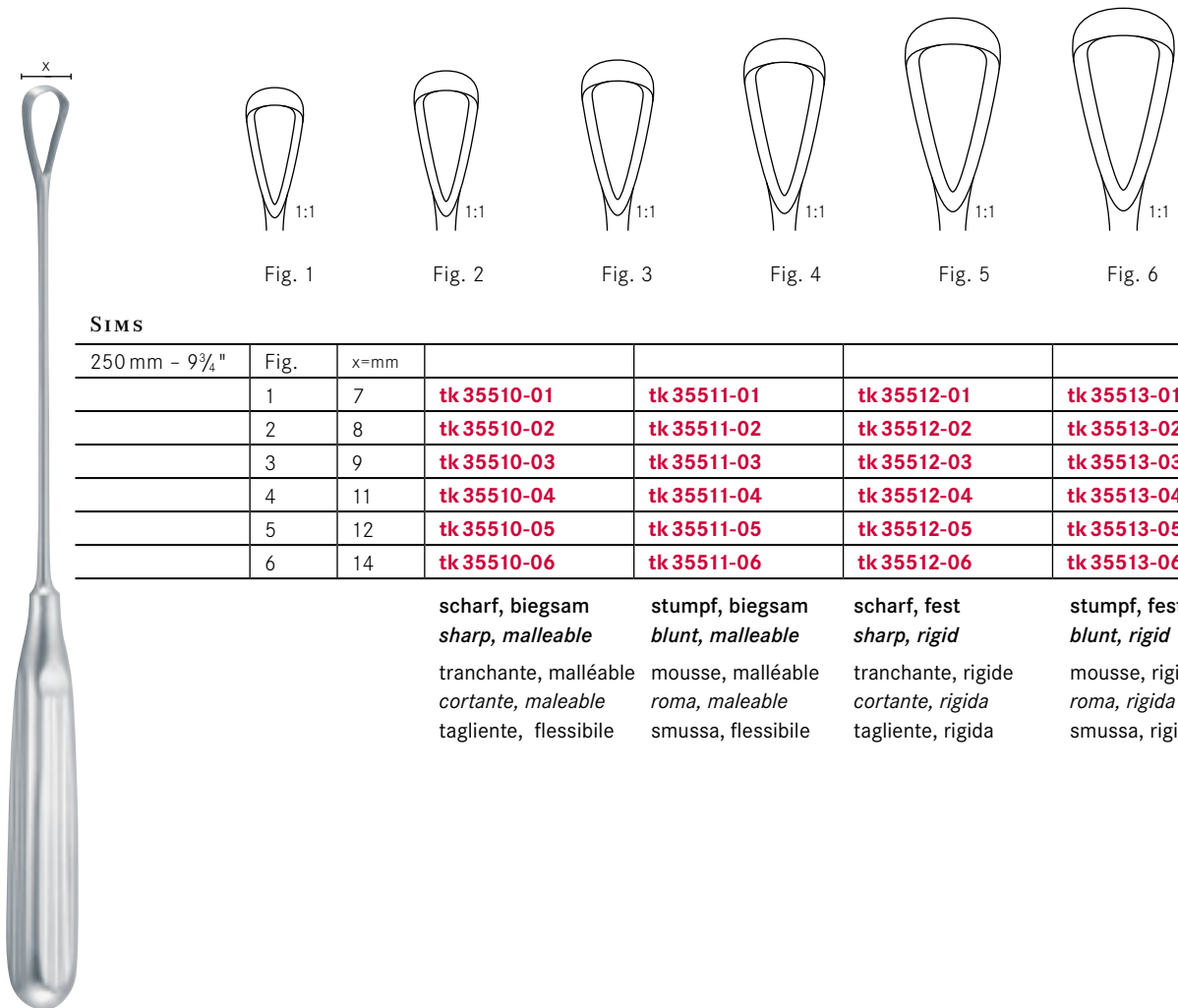

SIMS

250 mm - 9 3/4"	Fig.	x=mm				
	1	7	tk 35510-01	tk 35511-01	tk 35512-01	tk 35513-01
	2	8	tk 35510-02	tk 35511-02	tk 35512-02	tk 35513-02
	3	9	tk 35510-03	tk 35511-03	tk 35512-03	tk 35513-03
	4	11	tk 35510-04	tk 35511-04	tk 35512-04	tk 35513-04
	5	12	tk 35510-05	tk 35511-05	tk 35512-05	tk 35513-05
	6	14	tk 35510-06	tk 35511-06	tk 35512-06	tk 35513-06

scharf, biegsam
sharp, malleable

tranchante, malléable
cortante, maleable
 tagliente, flessibile

stumpf, biegsam
blunt, malleable

mousse, malléable
roma, maleable
 smussa, flessibile

scharf, fest
sharp, rigid

tranchante, rigide
cortante, rigida
 tagliente, rigida

stumpf, fest
blunt, rigid

mousse, rigid
roma, rigida
 smussa, rigida

Scharfe Löffel
Uterine spoons

Curettes tranchantes
Cucharillas cortantes
Cucchiai taglianti



SIMON



	Fig. 1	Fig. 2	Fig. 3
250 mm - 9 3/4"	tk 24445-01	tk 24445-02	tk 24445-03

scharf, fest
sharp, rigid
tranchante, rigide
cortante, rigida
taglianti, rigido

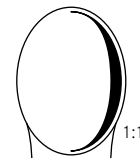
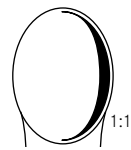
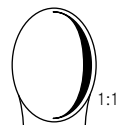

Fig. 4	Fig. 5	Fig. 6
tk 24445-04	tk 24445-05	tk 24445-06



SCHRÖDER

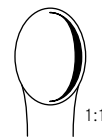
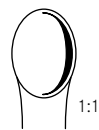

	Fig. 1	Fig. 2	Fig. 3
300 mm - 12"	tk 24448-01	tk 24448-02	tk 24448-03

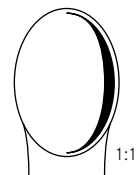
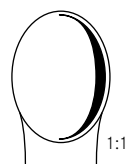
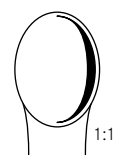

Fig. 4	Fig. 5	Fig. 6
tk 24448-04	tk 24448-05	tk 24448-06

Geburtszangen
Obstetrical forceps

Forceps obstétriques
Forceps obstétricos
Forcipi



SIMPSON

1:3

300 mm - 12"	tk 35600-30
--------------	--------------------



SIMPSON-
BRAUN

330 mm - 13"	tk 35601-33
360 mm - 14 $\frac{1}{4}$ "	tk 35601-36



NAEGELE

360 mm - 14 $\frac{1}{4}$ "	tk 35605-36
400 mm - 16"	tk 35605-40



PIPER

1:3

440 mm - 17 $\frac{1}{4}$ "	tk 35607-44
-----------------------------	--------------------

Geburtszangen
*Obstetrical forceps*Forceps obstétriques
Forceps obstétricos
ForcipiSIMPSON-
LUIKART

1:3

360 mm - 14 $\frac{1}{4}$ " **tk 35612-36**

1:3

WRIGLEY

230 mm - 9" **tk 35613-23**für Kaiserschnitt
for caesarian section
pour césarienne
para operación cesárea
per taglio cesareo

1:3

DELEE

300 mm - 12" **tk 35615-30**

DELEE

360 mm - 14 $\frac{1}{4}$ " **tk 35618-36**390 mm - 15 $\frac{1}{2}$ " **tk 35618-39**

Geburtszangen
Obstetrical forceps

Forceps obstétriques
Forceps obstétricos
Forcipi



ELLIOT

320 mm - 12½"	tk 35620-32
380 mm - 15"	tk 35620-38



MCLEAN

360 mm - 14¼"	tk 35622-36
---------------	--------------------



KIELLAND

410 mm - 16¼"	tk 35635-41
---------------	--------------------



KIELLAND-
LUIKART

400 mm - 16"	tk 35637-40
--------------	--------------------

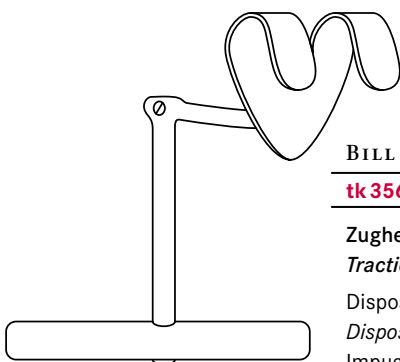

BILL

tk 35640-00

Zughebel, passend für alle Geburtszangen mit gehornem Standard-Griff
Traction handle for all the forceps with horned standard handle

Dispositif de traction pour tous les forceps avec manche normal à cornes
Dispositivo de tracción para todos los forceps con mango standard cornudo

Impugnatura di trazione adatto a tutti i forcipi con manico standard con corne

Geburtshilfe | Obstétrique
 Obstetrics | Obstetricia
 Ostetricia



SELLHEIM

280 mm - 11" | tk 35664-28

Geburtslöffel
 Obstetric lever

Cuillère obstétricale
 Cuchara obstétrica
 Cucchaio obstetrico



BRAUN

325 mm - 12¾" | tk 35745-30

Dekapitationshaken
 Decapitating hook

Crochet de décapitation
 Grancho de descapitación
 Uncino di decapitazione

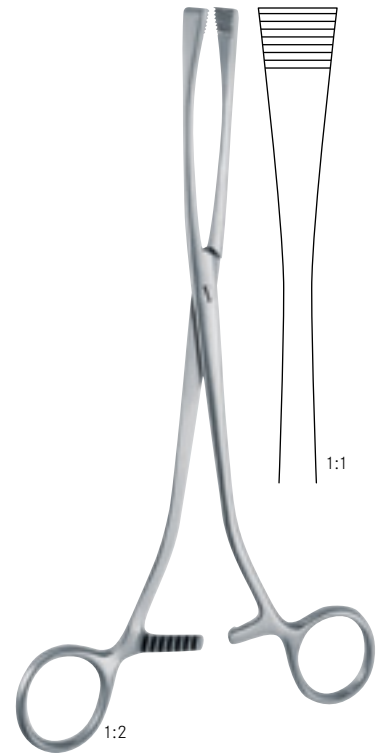

GREEN-
 ARMYTAGE

210 mm - 8¼" | tk 35665-21

Uterusklemmzange
 Uterine elevating forceps

Pince uterine
 Pinza para el útero
 Pinza uterina

Geburtshilfe | Obstétrique
Obstetrics | *Obstetricia*
Ostetricia



SMELLIE

250 mm - 10" **tk 35741-25**

Perforatorium
Perforator

Perforateur
Perforador
Perforatore



BRAUN

420 mm - 16½" **tk 35750-42**

Kranioklast, ein Maul gefenstert
Cranioclast, one jaw fenestrated

Cranioclaste, une partie fenestrée
Craneolasto, una boca fenestrada
Cranioclaste, un lato fenestrato



TARNIER

460 mm - 17¼" **tk 35748-46**

Basiotrib
Basiotribe

Basiotribe
Basiotribo
Basiotribo

Abortuszangen – Abortusküretten
Abortion forceps – Ovum curettes

Pinces à faux germes – Curette d'avortement
Pinzas para aborto – Curetas para aborto
 Pinze per placenta ed aborto – Curette per placenta ed aborto

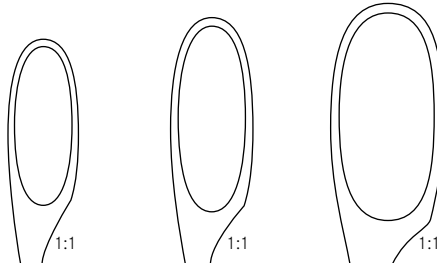

WINTER

	Fig. 1	Fig. 2	Fig. 3
280 mm - 11 "	tk 35701-28	tk 35702-28	tk 35703-28

gerade
straight
 droit
recta
 rette

tk 35711-28	tk 35712-28	tk 35713-28
--------------------	--------------------	--------------------

gebogen
curved
 courbe
curva
 curve

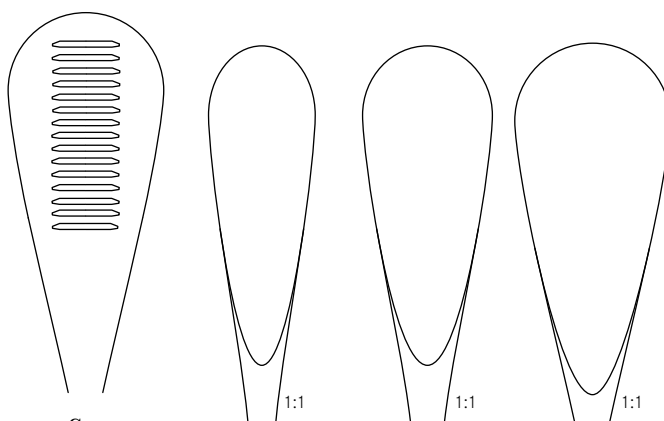

CUZZI

	14.5 mm	18.0 mm	21.0 mm
300 mm - 12 "	tk 35730-01	tk 35730-02	tk 35730-03

stumpf, Rückseite gerieft
blunt, back serrated
 mousse, dos strié
romo, dorso estriado
 smusso, dorso zigrinato

Abortuszangen – Abortusküretten
Abortion forceps – Ovum curettes

Pinces à faux germes – Curette d'avortement
Pinzas para aborto – Curetas para aborto

Pinze per placenta ed aborto – Curette per placenta ed aborto

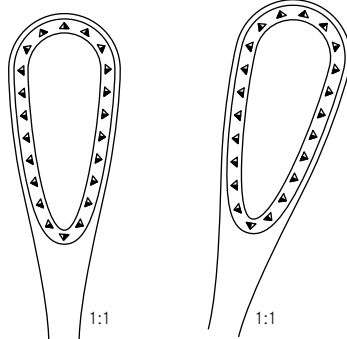

SAENGER

270 mm - 10³/₄"

tk 35720-27

tk 35721-27

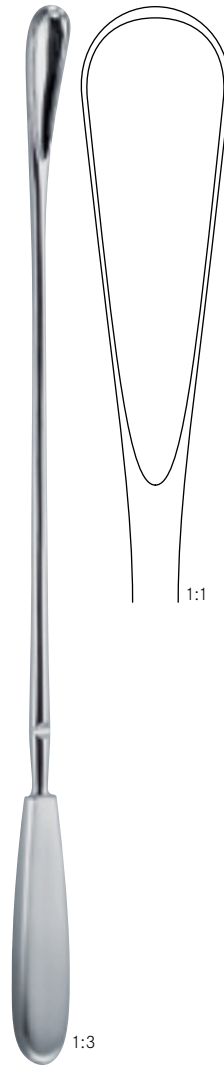

WALLICH

420 mm - 16¹/₂"

tk 35735-02

stumpf
blunt

mousse
roma
smussa



PESTALOZZA

300 mm - 12"

tk 35732-30

Nabelschnurklemmen
Umbilical cord clamps

Clamps pour le cordon ombilical
Clamps umbilicales
Pinze ombelicali

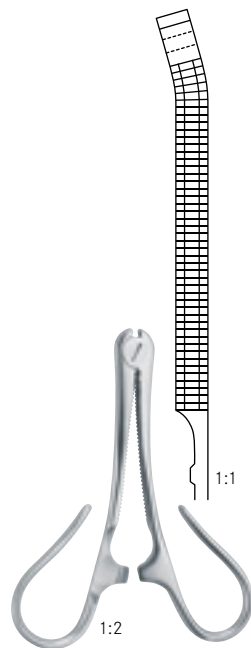

KANE

85 mm - 3/4" **tk 35760-08**



COLLIN

90 mm - 3/2" **tk 35761-09**

Beckenzirkel
Pelvimeters

Pelvimètres
Pelvimetros
Pelvimetri



MARTIN

340 mm - 13½" **tk 35800-34**

cm / Zoll-Scala
cm / inch-scale

échelle en cm / pouces
escala cm / pulgadas
scala cm / pollici



COLLIN

350 mm - 13¾" **tk 35805-35**

cm-Scala
cm-scale

échelle en cm
escala en cm
scala in cm