



Urologie  
*Urology*

Urologie  
*Urología*  
Urologia



**Nierensteinzangen**  
*Kidney stone forceps*

Pinces pour les calculs rénaux  
*Pinzas para cálculos renales*  
Pinze per calcoli renali

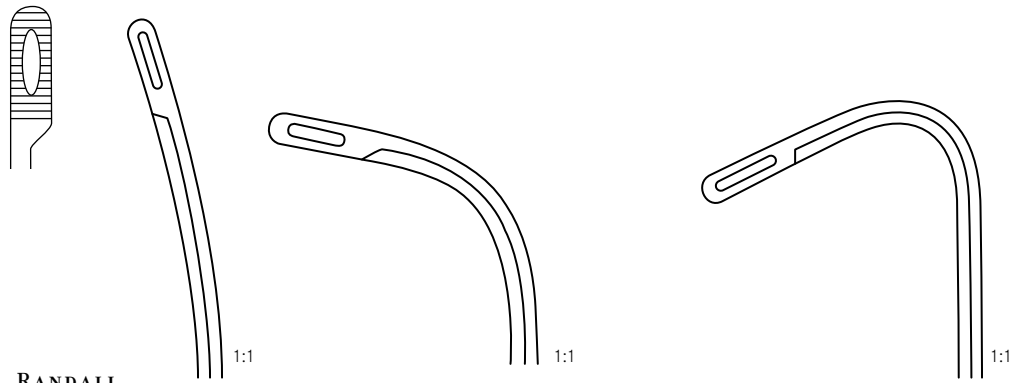

**RANDALL**

Fig. 1	Fig. 2	Fig. 3
230 mm - 9"	220 mm - 8 <sup>3</sup> / <sub>4</sub> "	190 mm - 7 <sup>1</sup> / <sub>2</sub> "
<b>tk 30221-23</b>	<b>tk 30222-22</b>	<b>tk 30223-22</b>

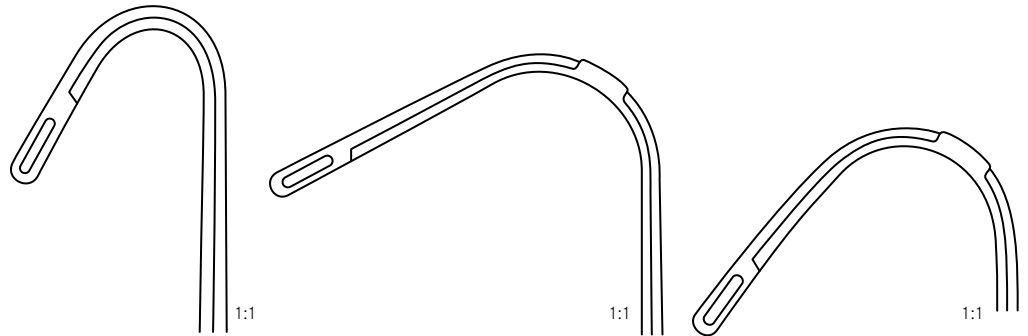

Fig. 4	Fig. 5	Fig. 6
190 mm - 7 <sup>1</sup> / <sub>2</sub> "	190 mm - 7 <sup>1</sup> / <sub>2</sub> "	190 mm - 7 <sup>1</sup> / <sub>2</sub> "
<b>tk 30224-22</b>	<b>tk 30225-19</b>	<b>tk 30226-19</b>

**Gallenstein-Instrumente**  
*Gall stone instruments*

Instruments pour calculs biliaires  
*Instrumental para coger cálculos biliares*  
Strumenti per canali bilari



1:3

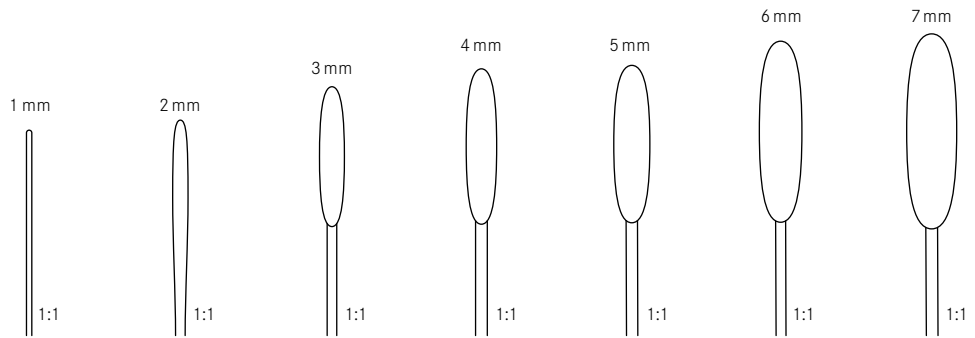

**BAKES**

	Fig. 1	Fig. 2	Fig. 3	Fig. 4	Fig. 5	Fig. 6	Fig. 7
300 mm - 12"	<b>tk 30100-01</b>	<b>tk 30100-02</b>	<b>tk 30100-03</b>	<b>tk 30100-04</b>	<b>tk 30100-05</b>	<b>tk 30100-06</b>	<b>tk 30100-07</b>

**biegsam**  
*malleable*  
malléable  
*maleable*  
flessibile

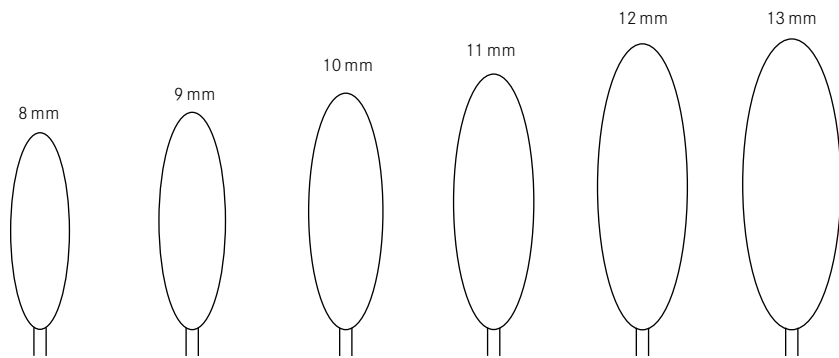
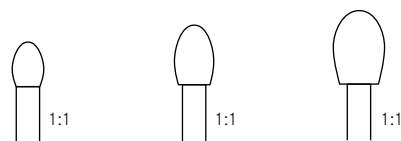

	Fig. 8	Fig. 9	Fig. 10	Fig. 11	Fig. 12	Fig. 13
300 mm - 12"	<b>tk 30100-08</b>	<b>tk 30100-09</b>	<b>tk 30100-10</b>	<b>tk 30100-11</b>	<b>tk 30100-12</b>	<b>tk 30100-13</b>

**biegsam**  
*malleable*  
malléable  
*maleable*  
flessibile



1:3



**DESIARDINS**

	Fig. 1	Fig. 2	Fig. 3
280 mm - 11"	<b>tk 30260-01</b>	<b>tk 30260-02</b>	<b>tk 30260-03</b>

**federnd**  
*elastic*  
élastique  
*elastica*  
elastico

Gallenstein-Instrumente  
Gall stone instruments

Instruments pour calculs biliaires  
Instrumental para coger cálculos biliares  
Strumenti per canali bilari



1:3

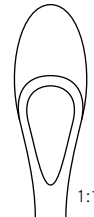

DESJARDINS

	Fig. 1	Fig. 2	Fig. 3	Fig. 4
300 mm - 12"	<b>tk 30110-01</b>	<b>tk 30110-02</b>	<b>tk 30110-03</b>	<b>tk 30110-04</b>

federnd  
elastic  
élastique  
elastica  
elastico



1:3

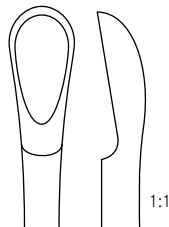

1:1



1:1

MOYNIHAN

	x = 5 mm
340 mm - 13 1/2"	<b>tk 30258-34</b>

biegsam  
malleable  
malléable  
maleable  
flessibile

Gallensteinlöffel  
Gall stone scoops

Curettes pour calculs biliaires  
Cucharillas para coger cálculos billares  
Cucchiai per colcoli bilari



LUER-KOERTE

	Fig. 000	Fig. 00	Fig. 0	Fig. 1
320 mm - 12½"	<b>tk 30285-01</b>	<b>tk 30285-02</b>	<b>tk 30285-03</b>	<b>tk 30285-04</b>

biegsam, stumpf  
malleable, blunt

malléable, mousse  
maleable, roma  
flessibile, smussa



	Fig. 2	Fig. 3	Fig. 4	Fig. 5
320 mm - 12½"	<b>tk 30285-05</b>	<b>tk 30285-06</b>	<b>tk 30285-07</b>	<b>tk 30285-08</b>

biegsam, stumpf  
malleable, blunt

malléable, mousse  
maleable, roma  
flessibile, smussa



MAYO

280 mm - 11"	<b>tk 30290-28</b>
--------------	--------------------

1:2

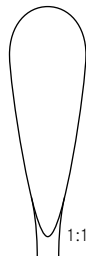

FERGUSSON

215 mm - 8½"	220 mm - 8¾"	235 mm - 9¼"
<b>tk 30295-21</b>	<b>tk 30295-22</b>	<b>tk 30295-23</b>

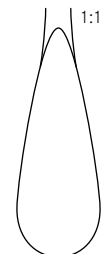
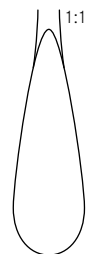

**Gallenstein-Instrumente**  
*Gall stone instruments*

Instruments pour calculs biliaires  
*Instrumental para coger cálculos biliares*  
Strumenti per canali bilari

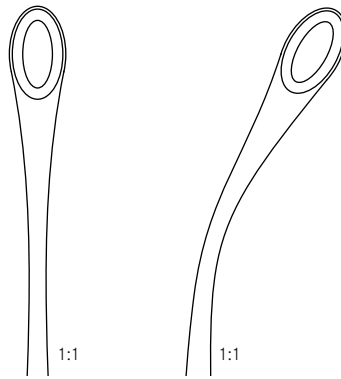

**BLAKE**

200 mm - 8"

**tk 30200-20**

**tk 30201-20**

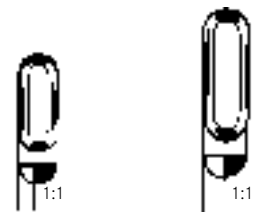

**DESJARDINS**

230 mm - 9"

**tk 30210-23**

**tk 30212-23**

Gallenstein-Instrumente  
*Gall stone instruments*

Instruments pour calculs biliaires  
*Instrumental para coger cálculos biliares*  
Strumenti per canali bilari



CZERNY

245 mm - 9<sup>3</sup>/<sub>4</sub>"

**tk 30267-25**



1:1



TURNER-  
WARWICK

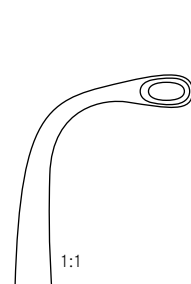

1:1

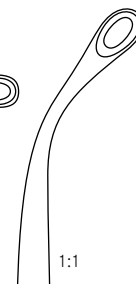

1:1

180 mm - 7"

190 mm - 7<sup>1</sup>/<sub>2</sub>"

**tk 30265-18**

**tk 30265-19**



Prostatahaken  
Prostatic retractors

Ecarteurs prostatiques  
Separadores para la próstata  
Divaricatori prostatici



YOUNG

tk 30300-21 | 210 mm - 8 1/4"

1:2

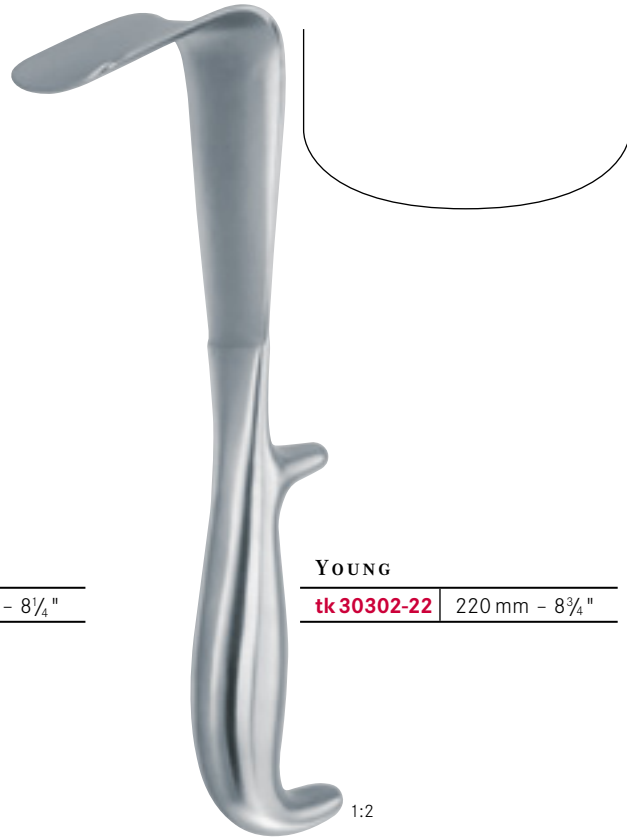

YOUNG

tk 30302-22 | 220 mm - 8 3/4"

1:2



YOUNG

tk 30304-21 | 210 mm - 8 1/4"

1:2

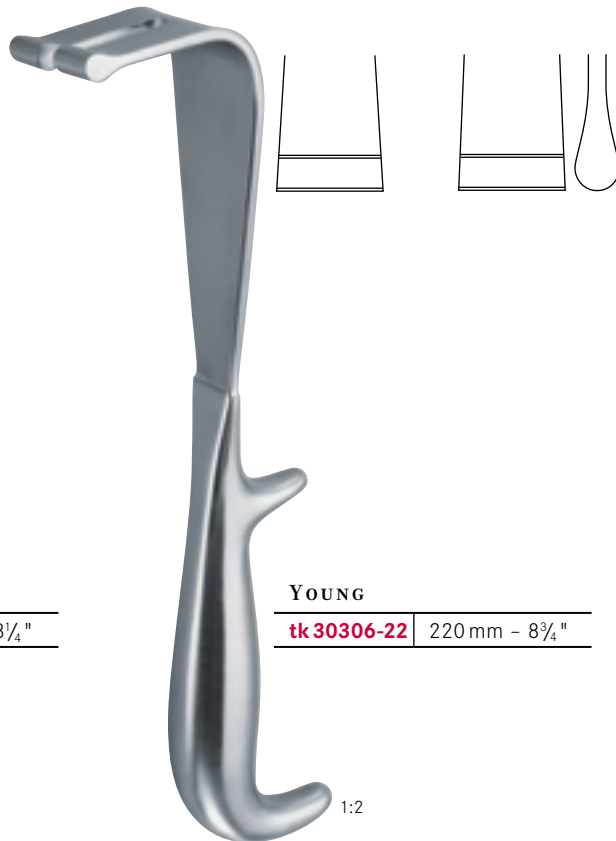

YOUNG

tk 30306-22 | 220 mm - 8 3/4"

1:2

Instrumente für Prostata-Operationen  
*Prostatectomy instruments*

Instruments pour prostatectomie  
*Instrumentos para prostatectomía*  
Strumenti per operazioni della prostata

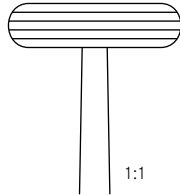

MILLIN

230 mm - 9"

**tk 30320-23**

Kapselfasszange zur retropubischen Prostatektomie  
*Capsule forceps for retropubic prostatectomy*

Pince pour saisir les capsules pour la prostatectomie rétropubique  
*Pinza capsular para le prostatectomía retropubica*  
Pinza a capsula per prostatectomia retropubica



MILLIN

230 mm - 9"

**tk 30322-23**

Fasszange für die vorderen Lappen  
*Prostatic lobe holding forceps*

Pince pour saisir les lambeaux  
*Pinza para coger los lóbulos anteriores*  
Pinza da presa per lobo prostatico

1:2

Instrumente für Prostata-Operationen  
*Prostatectomy instruments*

Instruments pour prostatectomie  
*Instrumentos para prostatectomía*  
Strumenti per operazioni della prostata

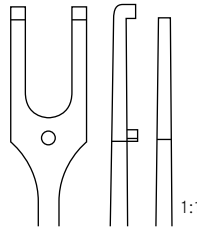

MILLIN

240 mm - 9½" tk 30324-24

Fadenführungszange  
*Ligatur carrying forceps*

Pince porte-fil  
*Pinza porta-ligaduras*  
Pinza per fili di sutura



YOUNG

205 mm - 8" tk 30310-20

Prostata-Fasszange  
*Prostate holding forceps*

Pince pour saisir la prostate  
*Pinza para coger la próstata*  
Pinza da presa per lobo prostatico

**Blasenwundspreizer**  
**Bladder retractors**

Ecarteurs vésicaux  
*Separadores vesicales*  
Divaricatori vescicali



**THOMSON-WALKER**

**tk 30335-00**

komplett mit 2 Paar Seitenvlaven, 1 Mittelvalve  
*complete with 2 pairs of lateral blades, 1 central blade*  
complet, avec 2 paires de valves latérales, 1 valve centrale  
*completo con 2 pares de valvas laterales, 1 valva central*  
completo, con 2 paia di valve laterali, 1 valva centrale



**MILLIN**

		57 mm x 25 mm	80 mm x 25 mm	120 mm x 45 mm
<b>tk 30352-00</b>	<b>tk 30352-10</b>	<b>tk 30352-11</b>	<b>tk 30352-12</b>	<b>tk 30352-13</b>
komplett	Sperrer, allein	2 Blätter	2 Blätter	1 Mittelblatt
complete	Spreader, only	2 Blades	2 Blades	1 Center blade
complet	Retracteur, seul	2 Valves	2 Valves	1 Valve centrale
completa	Retracteur, solo	2 Valvas	2 Valvas	1 Valva central
completa	Divaricatore, solo	2 Valve	2 Valve	1 Valva centrale

**tk 30352-01**

komplett mit Kaltlichtaufsatz  
*complete with cold light carrier*  
complet avec guide de lumière froide  
*completa con guía de luz fría*  
completa con portaluze fredda

**tk 30352-02**

**Kaltlichtaufsatz**  
**Cold light carrier**

Guide de lumière froide  
*Guía de luz fría*  
Porta luce fredda, solo

Blasenwundspreizer  
Bladder retractors

Ecarteurs vésicaux  
Separadores vesicales  
Divaricatori vescicali



LEGUEU  
tk 30336-00

1:3



JUDD-MASSON  
tk 30350-00

1:3



LEGUEU

x = 35 mm

270 mm - 10 3/4" tk 30361-27

1:3



KOCHER

x = 67 mm

260 mm - 10 1/4" tk 30363-26

1:3



MILLIN

285 mm - 11 1/4"

tk 30331-00

1:3

Dilatationsbougies  
Dilating bougies

Bougies dilatatrices  
Bujías dilatadoras  
Candelette dilatatrici

DITTEL

		220 mm - 8 $\frac{3}{4}$ "
2 $\frac{2}{3}$ mm Ø	8 Charr./Fr.	<b>tk 30390-08</b>
3 mm Ø	9 Charr./Fr.	<b>tk 30390-09</b>
3 $\frac{1}{3}$ mm Ø	10 Charr./Fr.	<b>tk 30390-10</b>
3 $\frac{2}{3}$ mm Ø	11 Charr./Fr.	<b>tk 30390-11</b>
4 mm Ø	12 Charr./Fr.	<b>tk 30390-12</b>
4 $\frac{1}{3}$ mm Ø	13 Charr./Fr.	<b>tk 30390-13</b>
4 $\frac{2}{3}$ mm Ø	14 Charr./Fr.	<b>tk 30390-14</b>
5 mm Ø	15 Charr./Fr.	<b>tk 30390-15</b>
5 $\frac{1}{3}$ mm Ø	16 Charr./Fr.	<b>tk 30390-16</b>
5 $\frac{2}{3}$ mm Ø	17 Charr./Fr.	<b>tk 30390-17</b>
6 mm Ø	18 Charr./Fr.	<b>tk 30390-18</b>
6 $\frac{1}{3}$ mm Ø	19 Charr./Fr.	<b>tk 30390-19</b>
6 $\frac{2}{3}$ mm Ø	20 Charr./Fr.	<b>tk 30390-20</b>
7 mm Ø	21 Charr./Fr.	<b>tk 30390-21</b>
7 $\frac{1}{3}$ mm Ø	22 Charr./Fr.	<b>tk 30390-22</b>
7 $\frac{2}{3}$ mm Ø	23 Charr./Fr.	<b>tk 30390-23</b>
8 mm Ø	24 Charr./Fr.	<b>tk 30390-24</b>
8 $\frac{1}{3}$ mm Ø	25 Charr./Fr.	<b>tk 30390-25</b>
8 $\frac{2}{3}$ mm Ø	26 Charr./Fr.	<b>tk 30390-26</b>
9 mm Ø	27 Charr./Fr.	<b>tk 30390-27</b>
9 $\frac{1}{3}$ mm Ø	28 Charr./Fr.	<b>tk 30390-28</b>
9 $\frac{2}{3}$ mm Ø	29 Charr./Fr.	<b>tk 30390-29</b>
10 mm Ø	30 Charr./Fr.	<b>tk 30390-30</b>
10 $\frac{2}{3}$ mm Ø	32 Charr./Fr.	<b>tk 30390-32</b>
11 mm Ø	33 Charr./Fr.	<b>tk 30390-33</b>
11 $\frac{1}{3}$ mm Ø	34 Charr./Fr.	<b>tk 30390-34</b>
12 mm Ø	36 Charr./Fr.	<b>tk 30390-36</b>

gerade  
straight

droit  
recta  
rette

DITTEL

		350 mm - 13 $\frac{3}{4}$ "
2 $\frac{2}{3}$ mm Ø	8 Charr./Fr.	<b>tk 30392-08</b>
3 mm Ø	9 Charr./Fr.	<b>tk 30392-09</b>
3 $\frac{1}{3}$ mm Ø	10 Charr./Fr.	<b>tk 30392-10</b>
3 $\frac{2}{3}$ mm Ø	11 Charr./Fr.	<b>tk 30392-11</b>
4 mm Ø	12 Charr./Fr.	<b>tk 30392-12</b>
4 $\frac{1}{3}$ mm Ø	13 Charr./Fr.	<b>tk 30392-13</b>
4 $\frac{2}{3}$ mm Ø	14 Charr./Fr.	<b>tk 30392-14</b>
5 mm Ø	15 Charr./Fr.	<b>tk 30392-15</b>
5 $\frac{1}{3}$ mm Ø	16 Charr./Fr.	<b>tk 30392-16</b>
5 $\frac{2}{3}$ mm Ø	17 Charr./Fr.	<b>tk 30392-17</b>
6 mm Ø	18 Charr./Fr.	<b>tk 30392-18</b>
6 $\frac{1}{3}$ mm Ø	19 Charr./Fr.	<b>tk 30392-19</b>
6 $\frac{2}{3}$ mm Ø	20 Charr./Fr.	<b>tk 30392-20</b>
7 mm Ø	21 Charr./Fr.	<b>tk 30392-21</b>
7 $\frac{1}{3}$ mm Ø	22 Charr./Fr.	<b>tk 30392-22</b>
7 $\frac{2}{3}$ mm Ø	23 Charr./Fr.	<b>tk 30392-23</b>
8 mm Ø	24 Charr./Fr.	<b>tk 30392-24</b>
8 $\frac{1}{3}$ mm Ø	25 Charr./Fr.	<b>tk 30392-25</b>
8 $\frac{2}{3}$ mm Ø	26 Charr./Fr.	<b>tk 30392-26</b>
9 mm Ø	27 Charr./Fr.	<b>tk 30392-27</b>
9 $\frac{1}{3}$ mm Ø	28 Charr./Fr.	<b>tk 30392-28</b>
9 $\frac{2}{3}$ mm Ø	29 Charr./Fr.	<b>tk 30392-29</b>
10 mm Ø	30 Charr./Fr.	<b>tk 30392-30</b>
10 $\frac{2}{3}$ mm Ø	32 Charr./Fr.	<b>tk 30392-32</b>
11 mm Ø	33 Charr./Fr.	<b>tk 30392-33</b>
11 $\frac{1}{3}$ mm Ø	34 Charr./Fr.	<b>tk 30392-34</b>
12 mm Ø	36 Charr./Fr.	<b>tk 30392-36</b>

gebogen  
curved

courbe  
curva  
curve

1:2

1:2

**Dilationsbougies** | **Bougies dilatatrices**  
**Dilating bougies** | **Bujías dilatadoras**  
**Candelette dilatatrici**



**VAN BUREN**

2½ mm Ø	8 Charr./Fr.	<b>tk 30391-08</b>
3½ mm Ø	10 Charr./Fr.	<b>tk 30391-10</b>
4 mm Ø	12 Charr./Fr.	<b>tk 30391-12</b>
4½ mm Ø	14 Charr./Fr.	<b>tk 30391-14</b>
5½ mm Ø	16 Charr./Fr.	<b>tk 30391-16</b>
6 mm Ø	18 Charr./Fr.	<b>tk 30391-18</b>
6½ mm Ø	20 Charr./Fr.	<b>tk 30391-20</b>
7½ mm Ø	22 Charr./Fr.	<b>tk 30391-22</b>
8 mm Ø	24 Charr./Fr.	<b>tk 30391-24</b>
8½ mm Ø	26 Charr./Fr.	<b>tk 30391-26</b>
9½ mm Ø	28 Charr./Fr.	<b>tk 30391-28</b>
10 mm Ø	30 Charr./Fr.	<b>tk 30391-30</b>
10½ mm Ø	32 Charr./Fr.	<b>tk 30391-32</b>
11½ mm Ø	34 Charr./Fr.	<b>tk 30391-34</b>
12 mm Ø	36 Charr./Fr.	<b>tk 30391-36</b>

**VAN BUREN**  
**tk 30391-00**

Satz, Fig. 08 – Fig. 36  
 Set, Fig. 08 – Fig. 36  
 Jeu, Fig. 08 – Fig. 36  
 Juego, Fig. 08 – Fig. 36  
 Serie, Fig. 08 – Fig. 36



**GUYON**

3½ mm Ø	10 Charr./Fr.	<b>tk 30393-10</b>
3½ mm Ø	11 Charr./Fr.	<b>tk 30393-11</b>
4 mm Ø	12 Charr./Fr.	<b>tk 30393-12</b>
4½ mm Ø	13 Charr./Fr.	<b>tk 30393-13</b>
4½ mm Ø	14 Charr./Fr.	<b>tk 30393-14</b>
5 mm Ø	15 Charr./Fr.	<b>tk 30393-15</b>
5½ mm Ø	16 Charr./Fr.	<b>tk 30393-16</b>
5½ mm Ø	17 Charr./Fr.	<b>tk 30393-17</b>
6 mm Ø	18 Charr./Fr.	<b>tk 30393-18</b>
6½ mm Ø	19 Charr./Fr.	<b>tk 30393-19</b>
6½ mm Ø	20 Charr./Fr.	<b>tk 30393-20</b>
7 mm Ø	21 Charr./Fr.	<b>tk 30393-21</b>
7½ mm Ø	22 Charr./Fr.	<b>tk 30393-22</b>
7½ mm Ø	23 Charr./Fr.	<b>tk 30393-23</b>
8 mm Ø	24 Charr./Fr.	<b>tk 30393-24</b>
8½ mm Ø	25 Charr./Fr.	<b>tk 30393-25</b>
8½ mm Ø	26 Charr./Fr.	<b>tk 30393-26</b>
9 mm Ø	27 Charr./Fr.	<b>tk 30393-27</b>
9½ mm Ø	28 Charr./Fr.	<b>tk 30393-28</b>
9½ mm Ø	29 Charr./Fr.	<b>tk 30393-29</b>
10 mm Ø	30 Charr./Fr.	<b>tk 30393-30</b>

**GUYON**  
**tk 30393-00**

Satz, Fig. 10 – Fig. 30, ohne Innengewinde  
 Set, Fig. 10 – Fig. 30, without inner thread  
 Jeu, Fig. 10 – Fig. 30, sans filet intérieur  
 Juego, Fig. 10 – Fig. 30, sin filete interior  
 Serie, Fig. 10 – Fig. 30, senza filetto interno

**Metallkatheter für Frauen**  
**Metal catheters for women**

Sondes métalliques pour femmes  
 Sondas metálicas para mujeres  
 Sonde metalliche per donne



**GUYON**

2 mm Ø	6 Charr./Fr.	<b>tk 30410-06</b>
2½ mm Ø	7 Charr./Fr.	<b>tk 30410-07</b>
2½ mm Ø	8 Charr./Fr.	<b>tk 30410-08</b>
3 mm Ø	9 Charr./Fr.	<b>tk 30410-09</b>
3½ mm Ø	10 Charr./Fr.	<b>tk 30410-10</b>
3½ mm Ø	11 Charr./Fr.	<b>tk 30410-11</b>
4 mm Ø	12 Charr./Fr.	<b>tk 30410-12</b>
4½ mm Ø	13 Charr./Fr.	<b>tk 30410-13</b>
4½ mm Ø	14 Charr./Fr.	<b>tk 30410-14</b>
5 mm Ø	15 Charr./Fr.	<b>tk 30410-15</b>
5½ mm Ø	16 Charr./Fr.	<b>tk 30410-16</b>
5½ mm Ø	17 Charr./Fr.	<b>tk 30410-17</b>
6 mm Ø	18 Charr./Fr.	<b>tk 30410-18</b>
6½ mm Ø	19 Charr./Fr.	<b>tk 30410-19</b>
6½ mm Ø	20 Charr./Fr.	<b>tk 30410-20</b>
7 mm Ø	21 Charr./Fr.	<b>tk 30410-21</b>
7½ mm Ø	22 Charr./Fr.	<b>tk 30410-22</b>
7½ mm Ø	23 Charr./Fr.	<b>tk 30410-23</b>
8 mm Ø	24 Charr./Fr.	<b>tk 30410-24</b>

Dilationsbougies  
*Dilating bougies*

Bougies dilatatrices  
*Bujías dilatadoras*  
Candelette dilatatrici

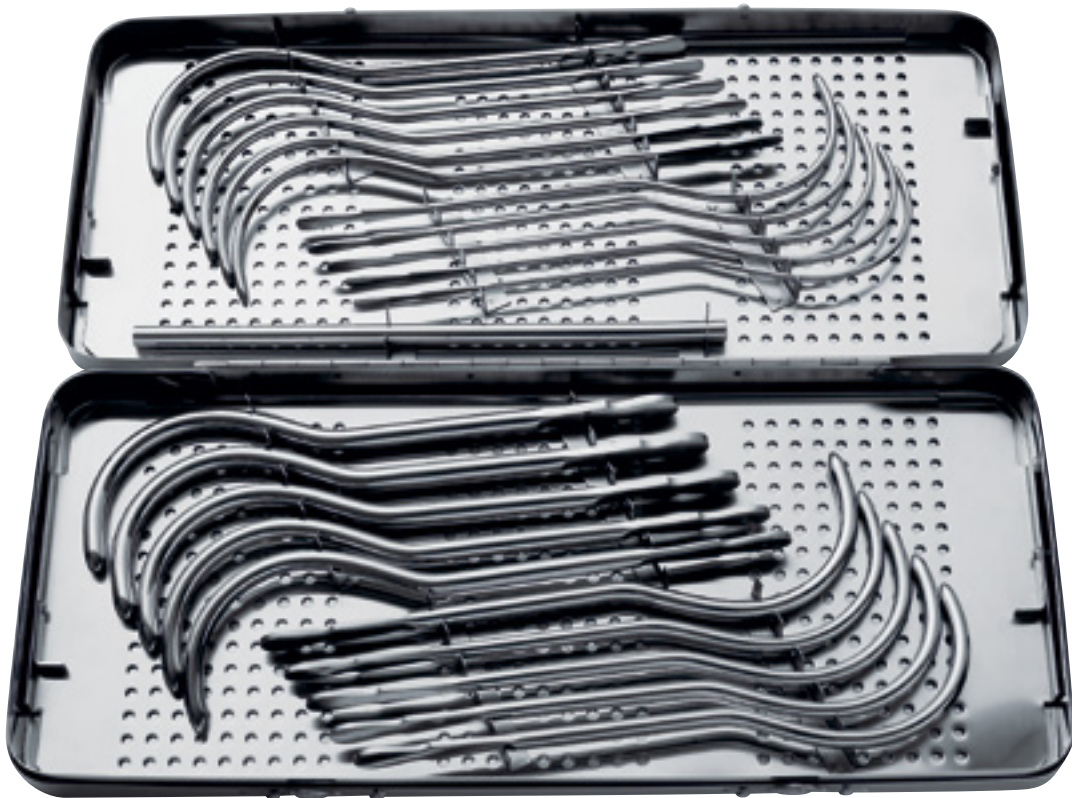

GUYON

420 mm x 175 mm x 40 mm

**tk 30398-00**

komplett, Charr. 10 - 30, im Edelstahl-Etui  
*complete, Charr. 10 - 30, in steel case*

complet, Charr. 10 - 30, en étui métallique  
*completa, Charr. 10 - 30, en caja metálica*

completa, Charr. 10 - 30, in astuccio metallico



Urethrotom  
*Urethrotome*

Urétrotome  
*Uretrótomo*  
 Uretrotomi



#### OTIS

**tk 30423-00**

komplett, im Holzetui  
 mit Dilatator, 2 Messern und 3 Ansätzen  
*complete in wooden case*  
*with dilator, 2 knives and 3 tips*  
 complet, en boîte de bois  
 avec dilateur, 2 lames et 3 embouts  
*completo en caja de madera*  
*con dilatador, 2 cuchillos y 3 puntas*  
 completo, in contenitore di legno  
 con dilatatore, 2 bisturi e 3 punte

**tk 30424-00**

Ersatzmesser  
*Spare blade*  
 Lame de rechange  
*Hoja de cambio*  
 Lama di ricambio



Urologie-Instrumente  
*Instruments for urology*

Instruments pour l'urologie  
*Instrumentos para la urología*  
Strumenti per urologia

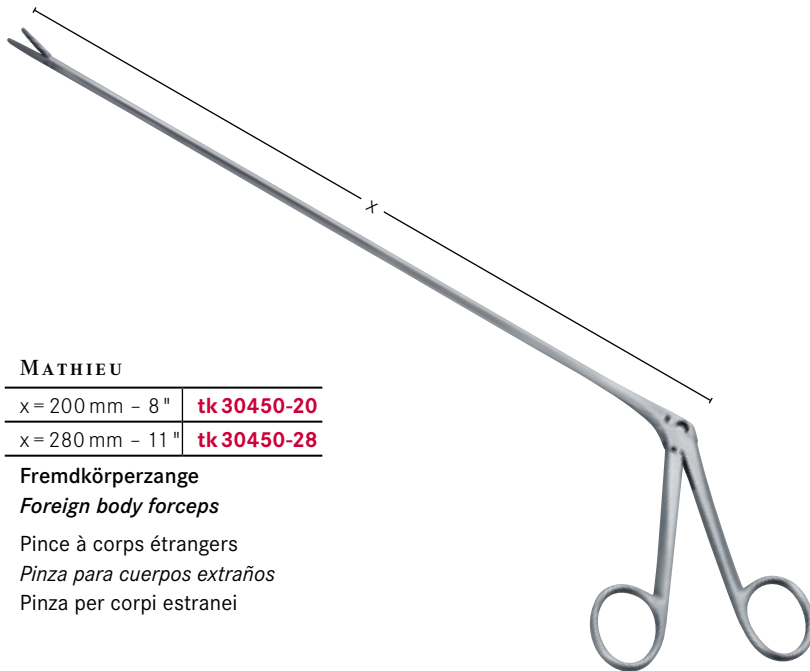

**MATHIEU**

x = 200 mm - 8" **tk 30450-20**

x = 280 mm - 11" **tk 30450-28**

**Fremdkörperzange**

*Foreign body forceps*

Pince à corps étrangers

*Pinza para cuerpos extraños*

Pinza per corpi estranei



1:2

160 mm - 6¼" **tk 17011-16**

**Samenstrang-Haken**

*Hook for the spermatic cord*

Crochet pour le cordon spermatique

*Grancho para el cordón espermático*

Uncino per dotto spermatico



1:3

1:3

**GUYON**

390 mm - 15½"

350 mm - 13¾"

**tk 30444-39**

**tk 30445-35**

**Katheterspanner**

*Mandrin for rubber catheters*

Mandrin pour cathéters

*Mandril para catéteres*

Introduttore per catheteri

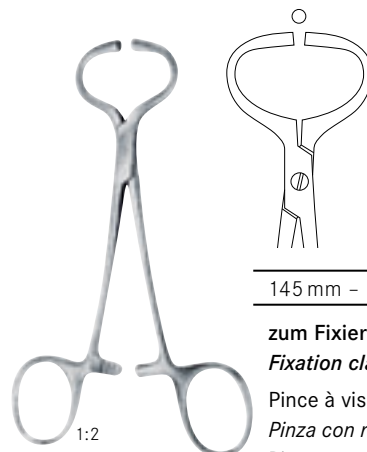

1:2

145 mm - 5¾" **tk 30467-14**

**zum Fixieren des Samenstranges**

*Fixation clamp for the spermatic cord*

Pince à vis pour fixation du cordon spermatique

*Pinza con rosca para fijación el cordon espermático*

Pinza con vite per fissare il funicolo spermatico

**Beschneidungsinstrumente**  
*Circumcision instruments*

Instrumentos de circuncision  
*Instrumentos para circuncisión*  
Strumenti per circuncisione



8 mm Ø	<b>tk 30456-08</b>
11 mm Ø	<b>tk 30456-11</b>
13 mm Ø	<b>tk 30456-13</b>
16 mm Ø	<b>tk 30456-16</b>
21 mm Ø	<b>tk 30456-21</b>
26 mm Ø	<b>tk 30456-26</b>
32 mm Ø	<b>tk 30456-32</b>



75 mm - 3"	<b>tk 30458-00</b>
------------	--------------------

**Beschneidungsklemme**  
*Circumcision instrument*

Instrument de circuncision  
*Instrumento para circuncisión*  
Strumento di circuncisione

**Beschneidungsklemme**  
*Circumcision instrument*

Instrument de circuncision  
*Instrumento para circuncisión*  
Strumento di circuncisione



140 mm - 5½"	<b>tk 30471-14</b>	<b>tk 30472-14</b>
--------------	--------------------	--------------------

**Vasectomieklemmen**  
*Vasectomy clamps*

Pinza para Vasectomia  
*Pince pour Vasectomie*  
Pinza per vasectomia

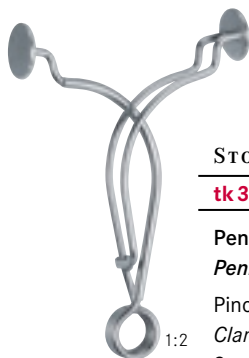

**STOCKMANN**  
**tk 30460-08**

**Penisklemme**  
*Penis clamp*  
Pince pour le pénis  
*Clamp para el pene*  
Serrapene



**STRAUSS**  
**tk 30465-11**

**Penisklemme**  
*Penis clamp*  
Pince pour le pénis  
*Clamp para el pene*  
Serrapene

