



Magen, Darm  
*Stomach, Intestine*

Estomac, Intestins  
*Estómago, Intestino*  
Stomaco, Intestino





**Gewebe- und Darmfasszangen**  
**Tissue and intestinal holding forceps**

Pinces intestinales et de tissu  
Pinzas para tejidos y intestinos  
Pinze per tessuti ed intestinali



**ALLIS-BABY**

140 mm - 5½" **tk 28100-14**

Zähne 4x5  
Teeth

Dents  
Dientes  
Denti



**ALLIS**

150 mm - 6"	<b>tk 28140-15</b>	<b>tk 28160-15</b>
190 mm - 7½"		<b>tk 28160-19</b>
250 mm - 9¾"		<b>tk 28160-25</b>

Zähne 4x5 5x6  
Teeth  
Dents  
Dientes  
Denti



**ALLIS-ADAIR**

155 mm - 6" **tk 28167-15**

Zähne 10x11  
Teeth

Dents  
Dientes  
Denti



**THOMS-ALLIS**

200 mm - 8" **tk 28180-20**

6x7



**LOCKWOOD**

200 mm - 8" **tk 28190-20**

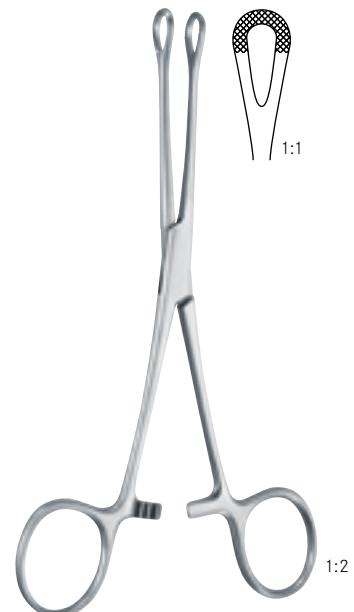

**WILLIAMS**

160 mm - 6¼" **tk 28192-16**

Gewebe- und Darmfazzangen  
Tissue and intestinal holding forceps

Pinces intestinales et de tissue  
Pinzas para tejidos y intestinos  
Pinze per tessuti ed intestinali



**LITTLEWOOD**

190 mm - 7½" **tk 11955-19**

Zähne 2x3

Teeth

Dents

Dientes

Denti



**BOYS-ALLIS**

150 mm - 6" **tk 28210-15**

Zähne 5x6

Teeth

Dents

Dientes

Denti



**JUDD-ALLIS**

150 mm - 6" **tk 28250-15**

190 mm - 7½" **tk 28250-19**

Zähne 3x4

Teeth

Dents

Dientes

Denti



**BABCOCK**

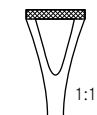

160 mm - 6¼" **tk 28285-16**

200 mm - 8" **tk 28285-20**

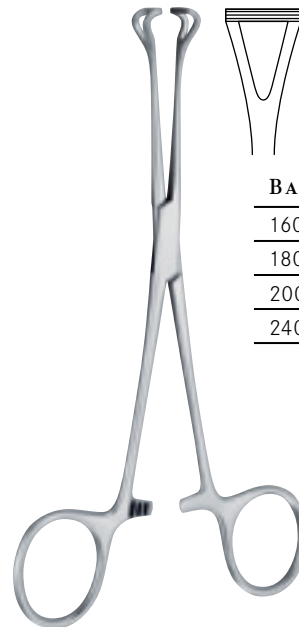

**BABCOCK**

160 mm - 6¼" **tk 28280-16**

180 mm - 7" **tk 28280-18**

200 mm - 8" **tk 28280-20**

240 mm - 9½" **tk 28280-24**

**Gewebe- und Darmfasszangen**  
*Tissue and intestinal holding forceps*

Pinces intestinales et de tissue  
*Pinzas para tejidos y intestinos*  
 Pinze per tessuti ed intestinali

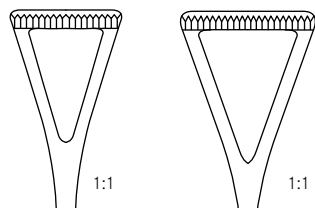
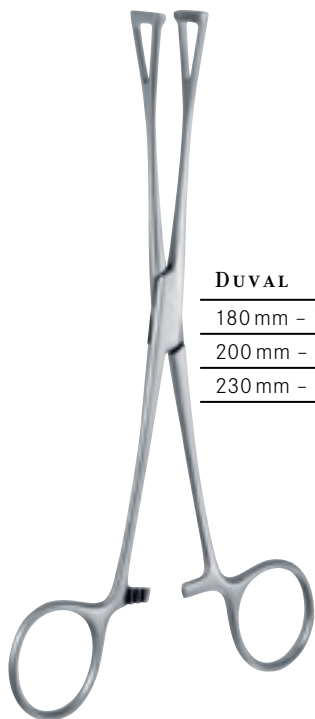

**DUVAL**

180 mm - 7"	<b>tk 28290-18</b>	
200 mm - 8"	<b>tk 28290-20</b>	<b>tk 28292-20</b>
230 mm - 9"	<b>tk 28290-23</b>	<b>tk 28292-23</b>

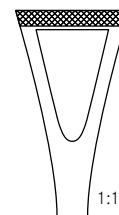

**DUVAL**

200 mm - 8"	<b>tk 28293-20</b>
-------------	--------------------

**TUGARK**

1:2

Gewebe- und Darmfazzangen  
*Tissue and intestinal holding forceps*

Pinces intestinales et de tissue  
*Pinzas para tejidos y intestinos*  
Pinze per tessuti ed intestinali

**ATRAUM**TK

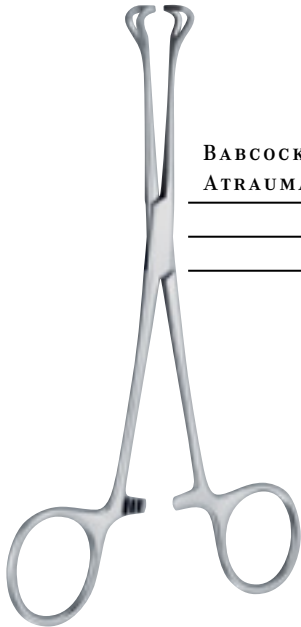

**BABCOCK-  
ATRAUMA**

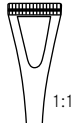

1:1



1:1

160 mm – 6¼"

200 mm – 8"

**tk 22452-16**

**tk 22452-20**



**DUVAL-  
ATRAUMA**

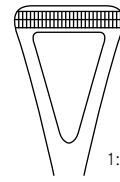

1:1

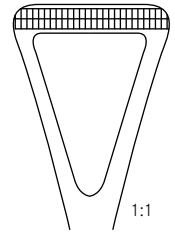

1:1

200 mm – 8"

230 mm – 9"

**tk 22455-20**

**tk 22455-23**



**ALLIS-  
ATRAUMA**



1:1



1:1

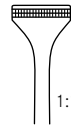

1:1

160 mm – 6¼"

200 mm – 8"

250 mm – 9¾"

**tk 22450-16**

**tk 22450-20**

**tk 22450-25**

**Darm- und Magenklammern**  
*Intestinal and stomach clamps*

Pinces-clamps pour l'intestin et l'estomac  
*Pinzas-clamps para el intestino y el estomago*  
Pinze per intestino e stomaco

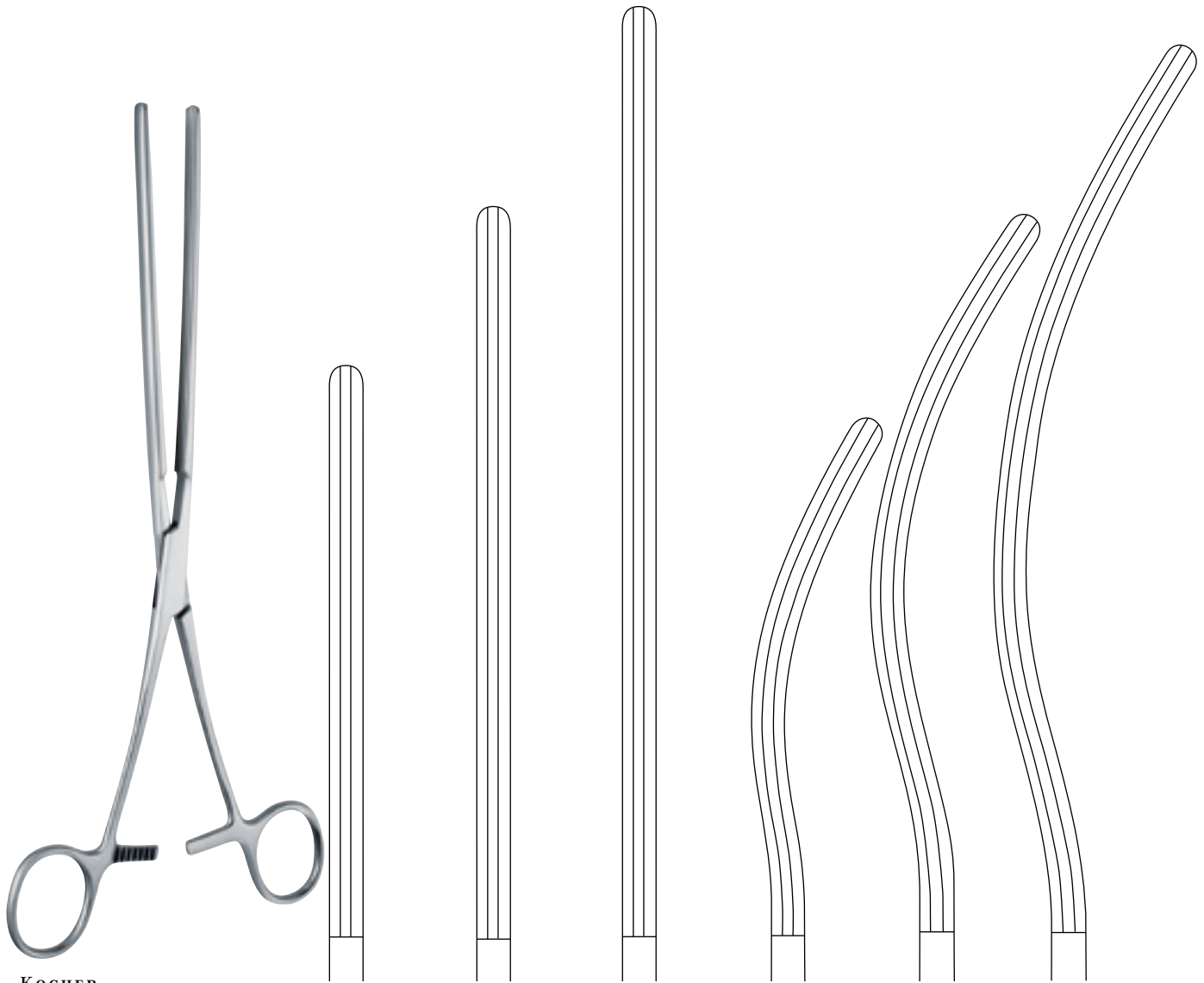

**KOCHER**

	220 mm - 8¾"	250 mm - 9¾"	280 mm - 11"	220 mm - 8¾"	250 mm - 9¾"	280 mm - 11"
	<b>tk 28300-22</b>	<b>tk 28300-25</b>	<b>tk 28300-28</b>	<b>tk 28301-22</b>	<b>tk 28301-25</b>	<b>tk 28301-28</b>

Darm- und Magenklammern  
*Intestinal and stomach clamps*

Pinces-clamps pour l'intestin et l'estomac  
*Pinzas-clamps para el intestino y el estomago*  
 Pinze per intestino e stomaco

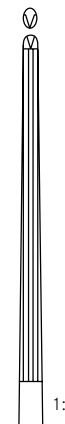
**ALLEN**  
 155 mm – 6" | **tk 28302-15**

1x2  
 Darmklemme für Kinder  
*Intestinal clamp for children*  
 Pince intestinal pour enfants  
*Pinza intestinal para niños*  
 Pinza intestinale per bambini

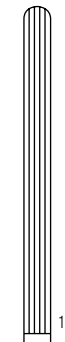
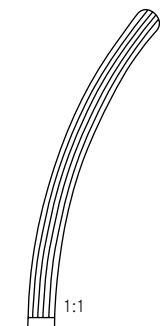

1:2

**BABY-KOCHER**  
 130 mm – 5" | **tk 28305-13** | **tk 28306-13**



Darmklemme für Kinder, sehr elastisch  
*Intestinal clamp for children, very elastic blades*  
 Pince intestinal pour enfants, très élastique  
*Pinza intestinal para niños, muy elastica*  
 Pinza intestinale per bambini, molto elastica

1:2

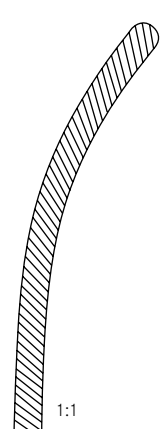
**BABY-DOYEN**  
 180 mm – 7" | **tk 28314-18** | **tk 28315-18**

1:2

**DOYEN**  
 210 mm – 8¼" | **tk 28310-21** | **tk 28311-21**  
 230 mm – 9" | **tk 28310-23** | **tk 28311-23**

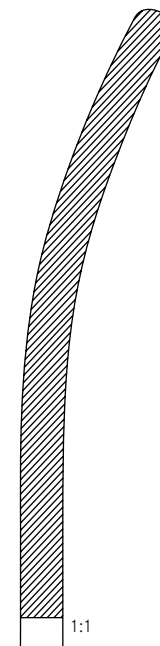
1:2



**Darm- und Magenklammern**  
*Intestinal and stomach clamps*

Pinces-clamps pour l'intestin et l'estomac  
*Pinzas-clamps para el intestino y el estomago*  
Pinze per intestino e stomaco

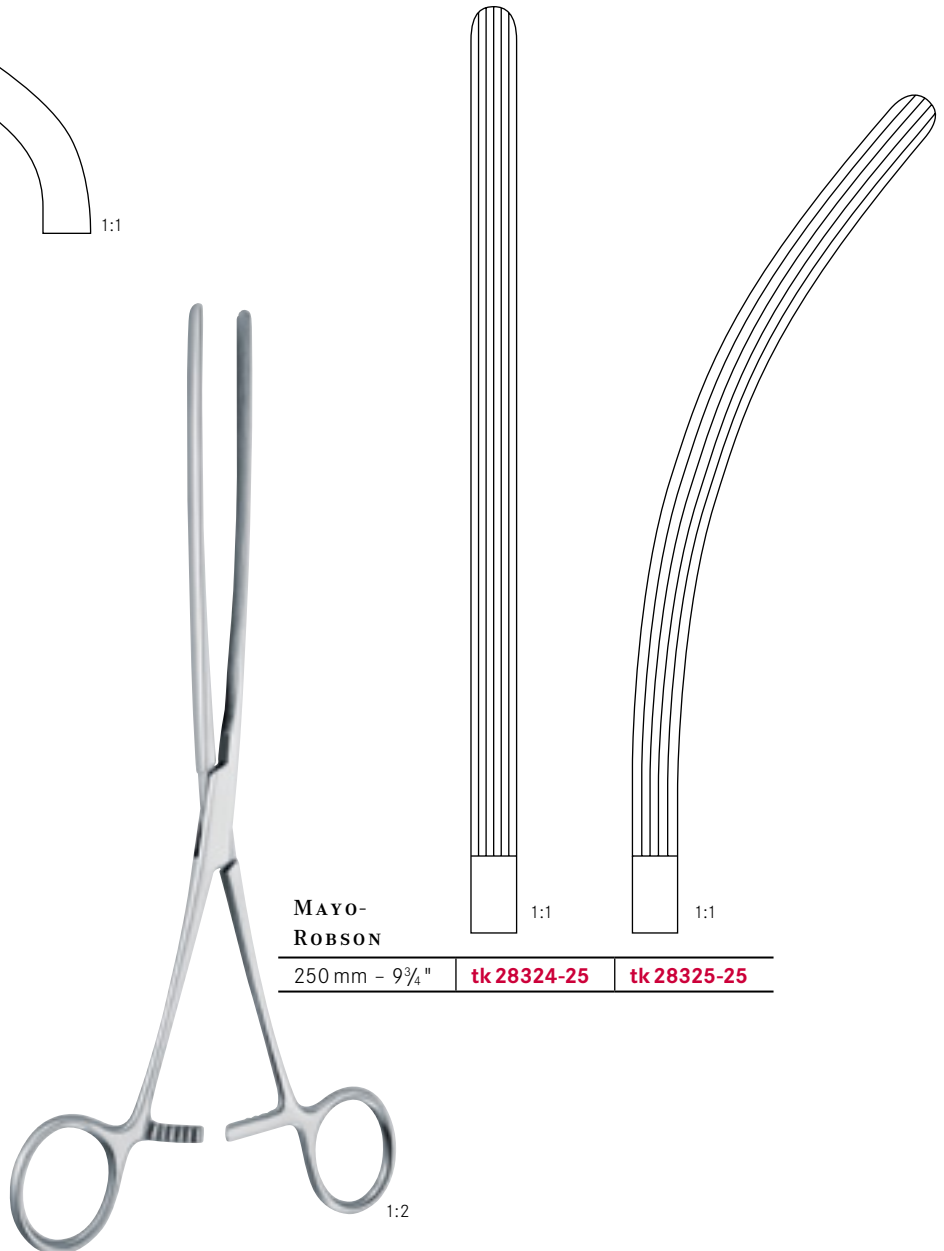
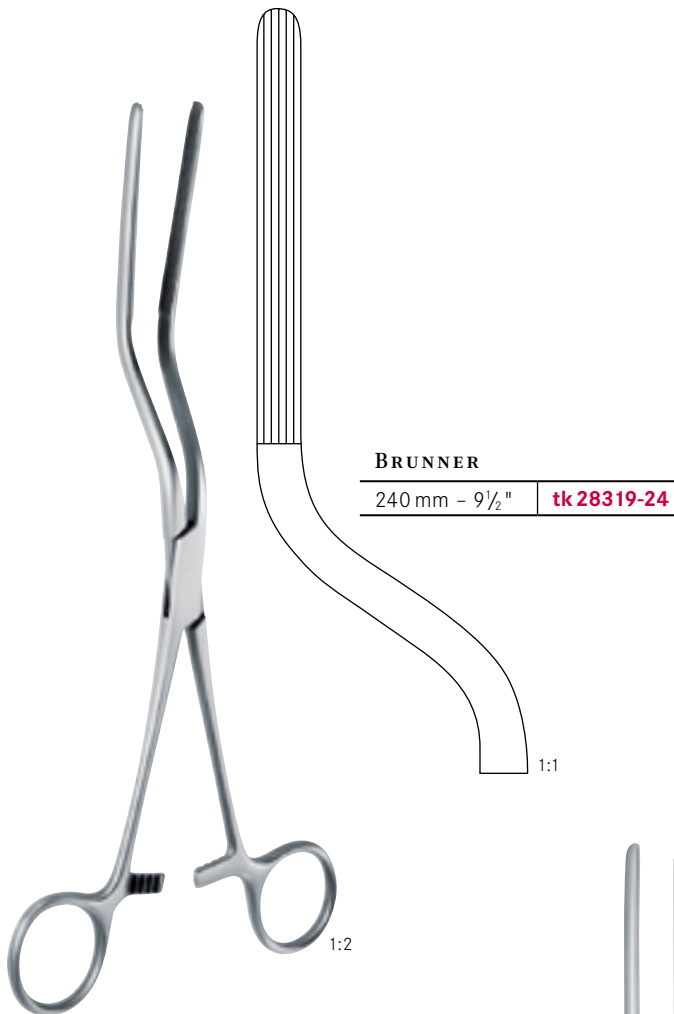

Darm- und Magenklammern  
*Intestinal and stomach clamps*

Pinces-clamps pour l'intestin et l'estomac  
*Pinzas-clamps para el intestino y el estomago*  
Pinze per intestino e stomaco

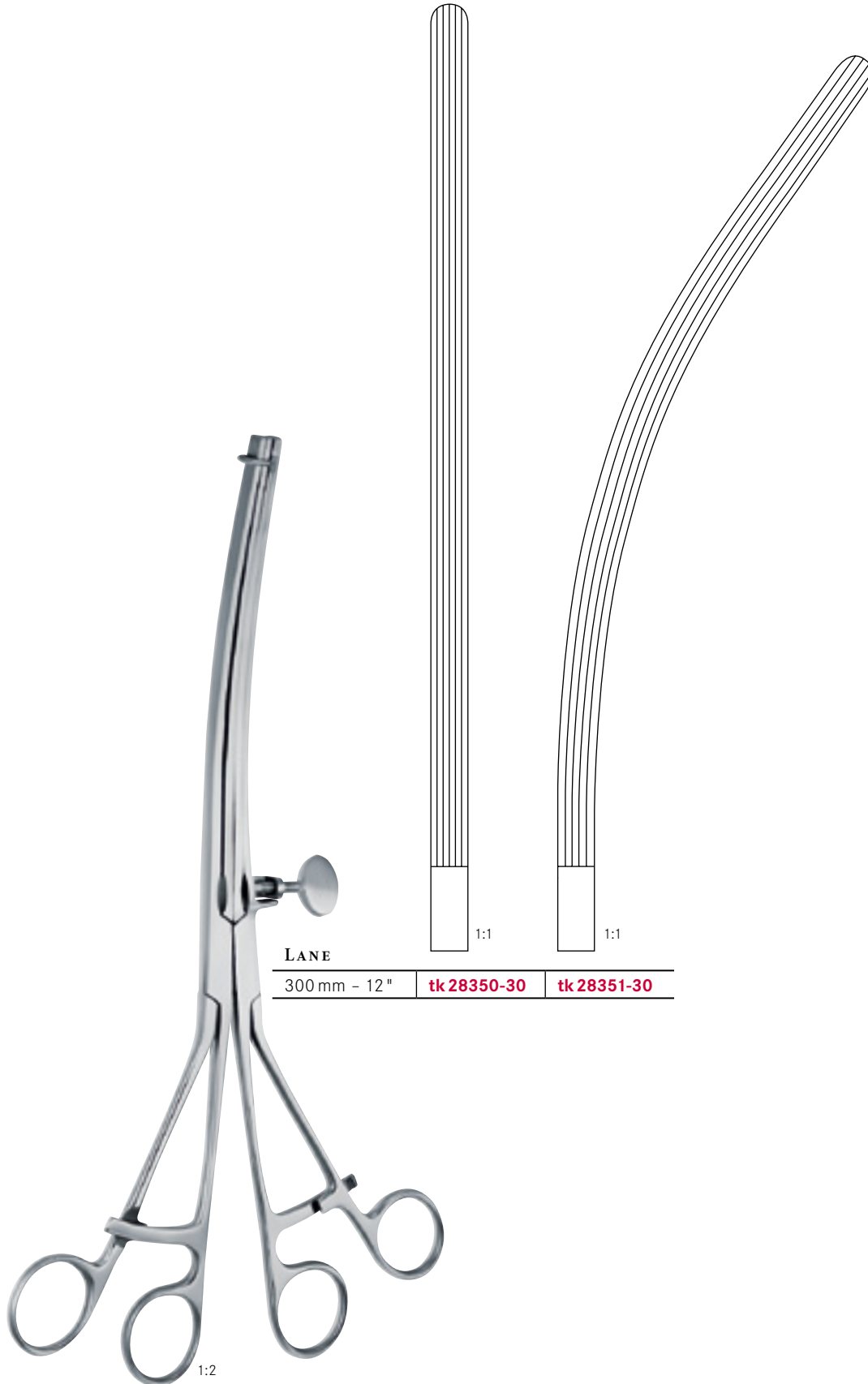

**Atraumatische Darmklemmen**  
*Atraumatic intestinal clamp forceps*

Pinces-clamps atraumatiques pour l'intestin  
*Pinzas-clamps atraumáticas intestinales*  
Pinze intestinali atraumatiche

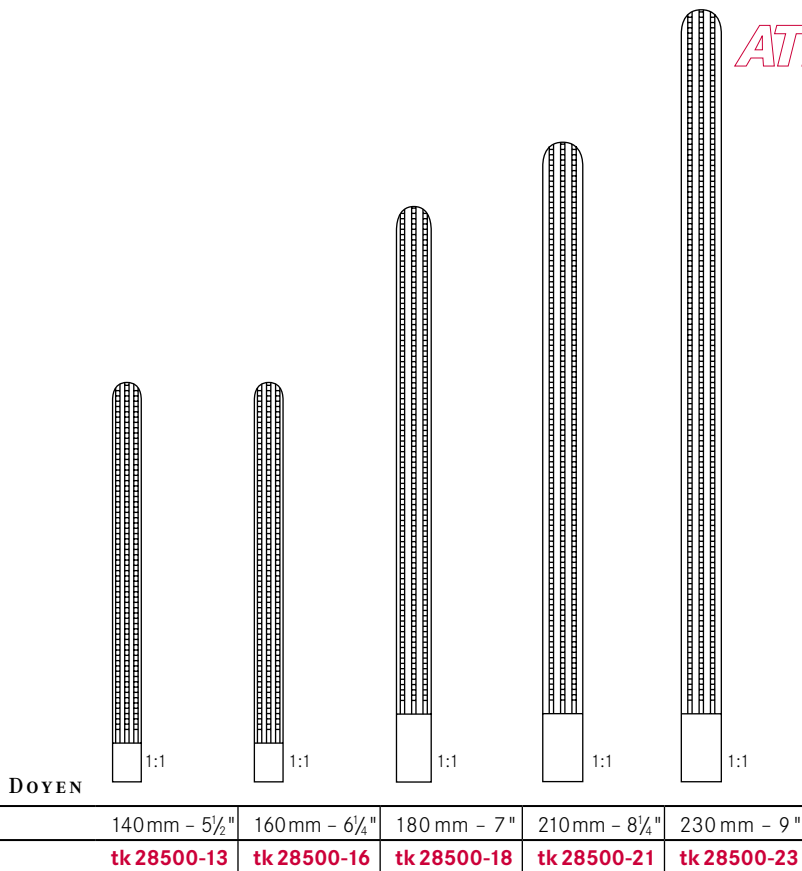

**ATRAUMTK**

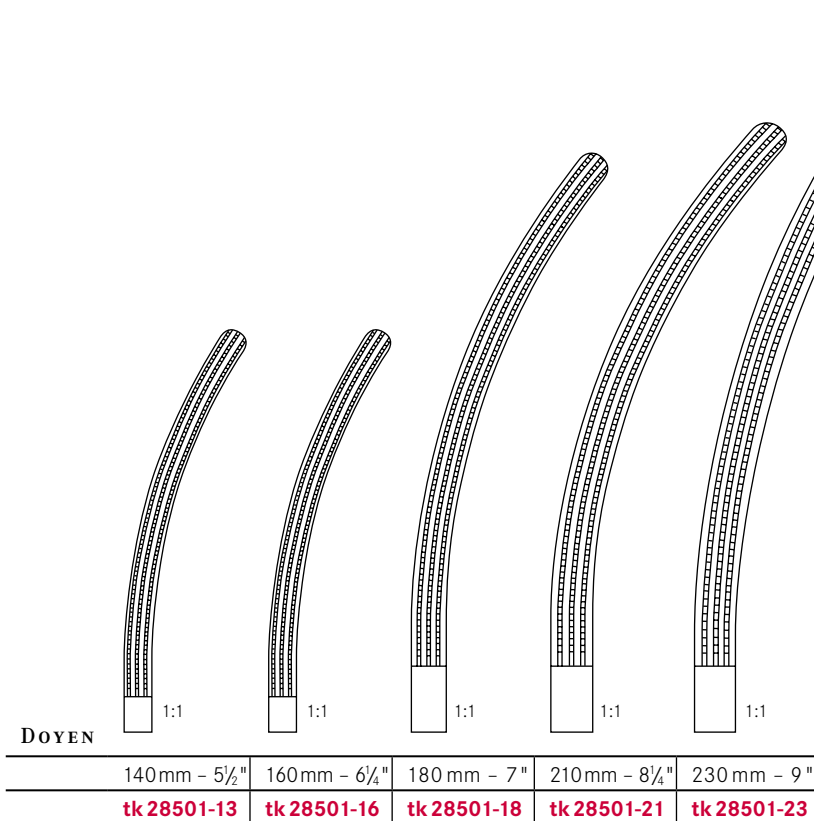

Atraumatische Darmklemmen  
*Atraumatic intestinal clamp forceps*

Pinces-clamps atraumatiques pour l'intestin  
*Pinzas-clamps atraumáticas intestinales*  
Pinze intestinali atraumatiche

**ATRAUMTK**

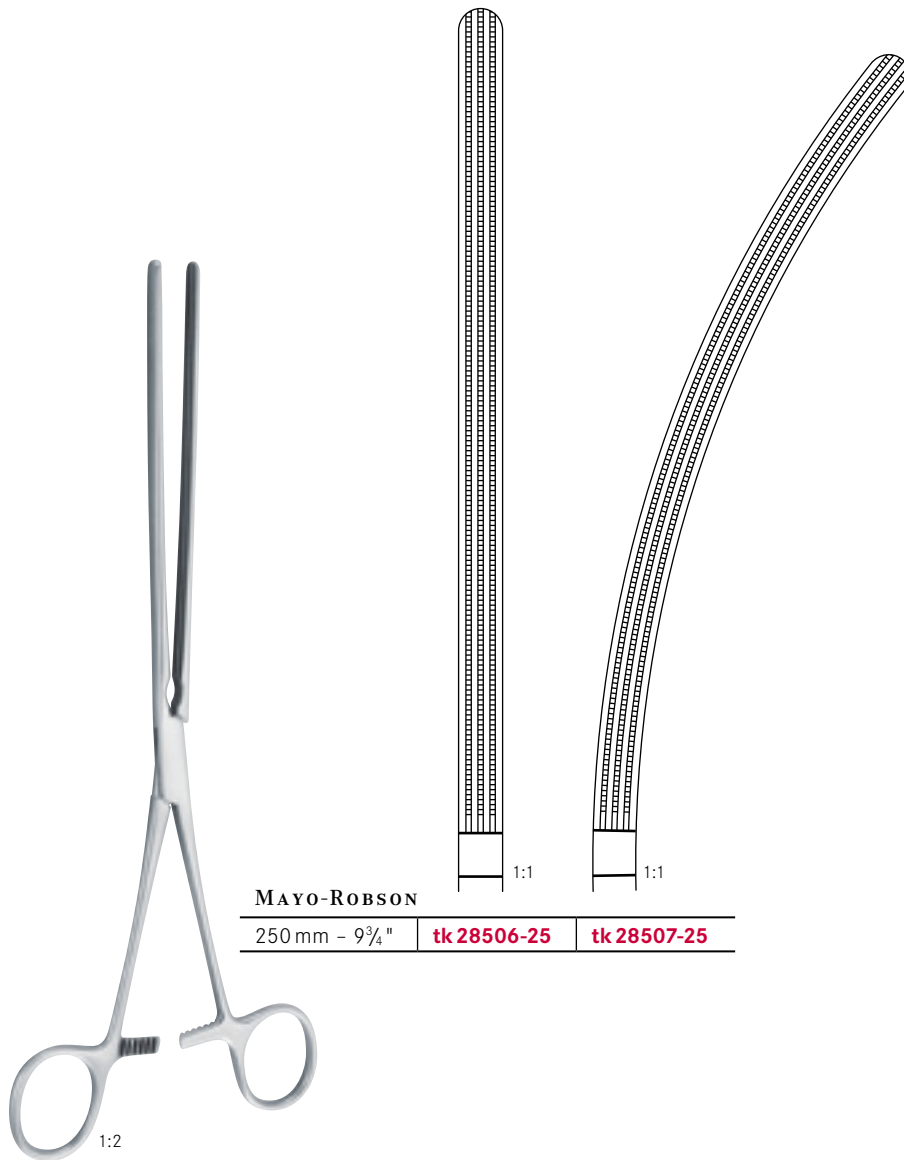

Atraumatische Darmklemmen  
*Atraumatic intestinal clamp forceps*

Pinces-clamps atraumatiques pour l'intestin  
*Pinzas-clamps atraumáticas intestinales*  
 Pinze intestinali atraumatiche

**ATRAUMTK**

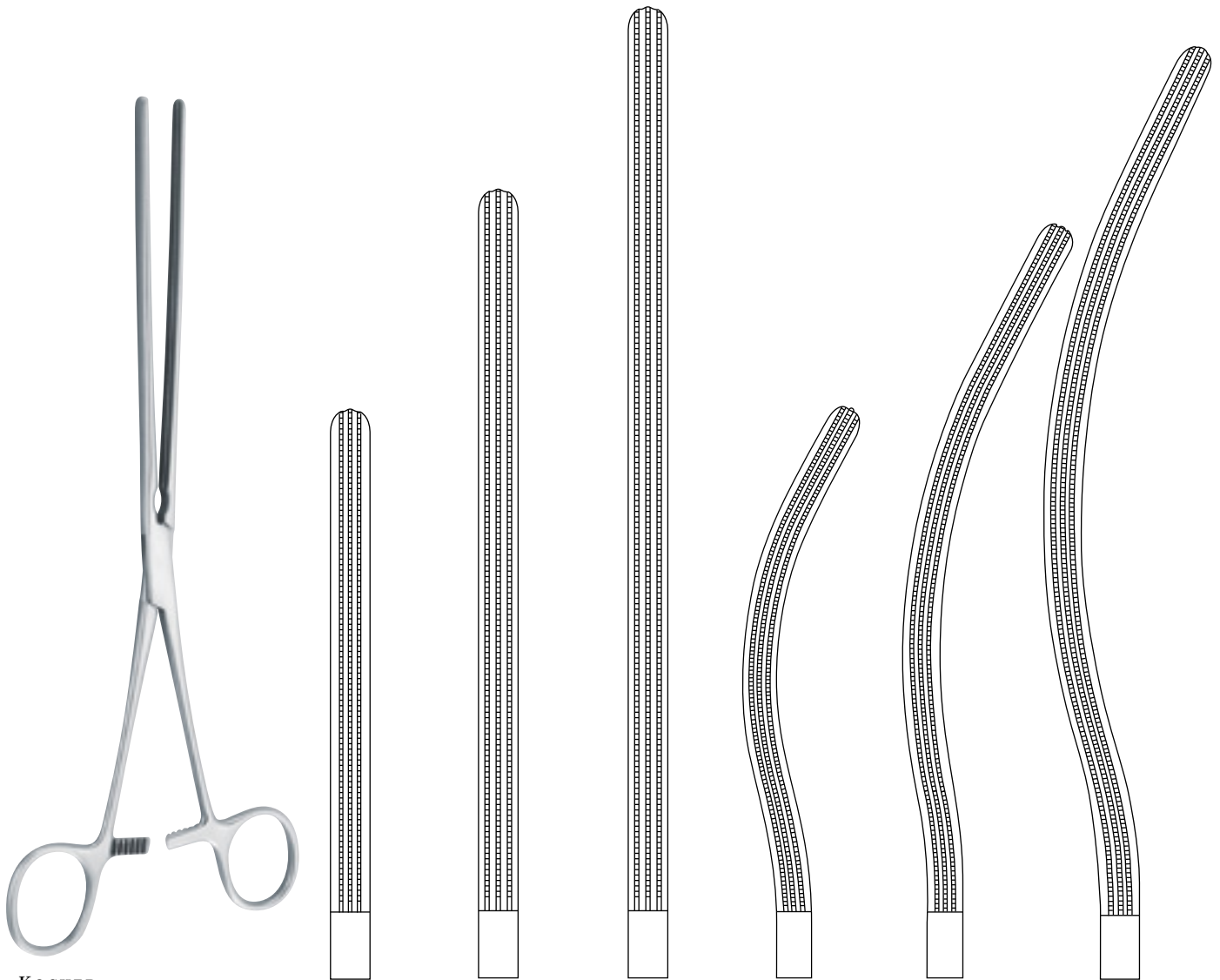

KOCHER

	220 mm - 8 <sup>3</sup> / <sub>4</sub> "	250 mm - 9 <sup>3</sup> / <sub>4</sub> "	280 mm - 11 "	220 mm - 8 <sup>3</sup> / <sub>4</sub> "	250 mm - 9 <sup>3</sup> / <sub>4</sub> "	280 mm - 11 "
	<b>tk 28510-22</b>	<b>tk 28510-25</b>	<b>tk 28510-28</b>	<b>tk 28511-22</b>	<b>tk 28511-25</b>	<b>tk 28511-28</b>

Atraumatische Darmklemmen  
*Atraumatic intestinal clamp forceps*

Pinces-clamps atraumatiques pour l'intestin  
*Pinzas-clamps atraumáticas intestinales*  
Pinze intestinali atraumatiche

**ATRAUM**TK



RESANO

300 mm - 12"

tk 28529-30

1:1

1:2

Rektum-Anastomosenklemmen  
Sigmoid anastomosis forceps

Pinces pour anastomoses rectales  
Pinzas para anastomosis rectales  
Pinze per anastomosi rettali

ATRAUMTK

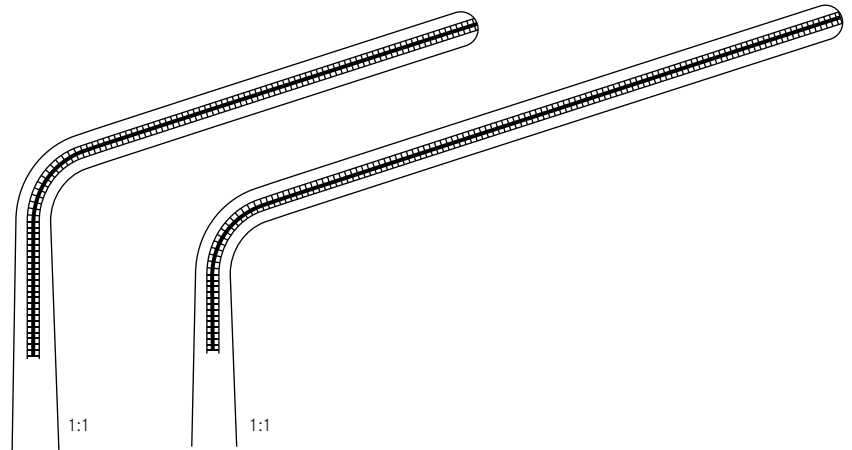

HAYES

260 mm - 10 1/4"	280 mm - 11"
tk 28526-26	tk 28526-28

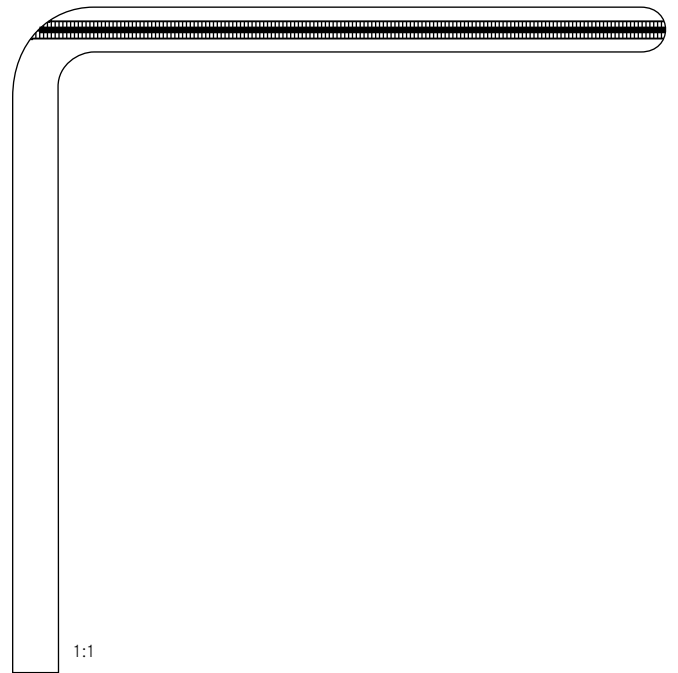

FEHLÄND

240 mm - 9 1/2"
tk 28528-24

Rektum-Anastomosenklemmen  
*Sigmoid anastomosis forceps*

Pinces pour anastomoses rectales  
*Pinzas para anastomosis rectales*  
Pinze per anastomosi rettali

**ATRAUMTK**

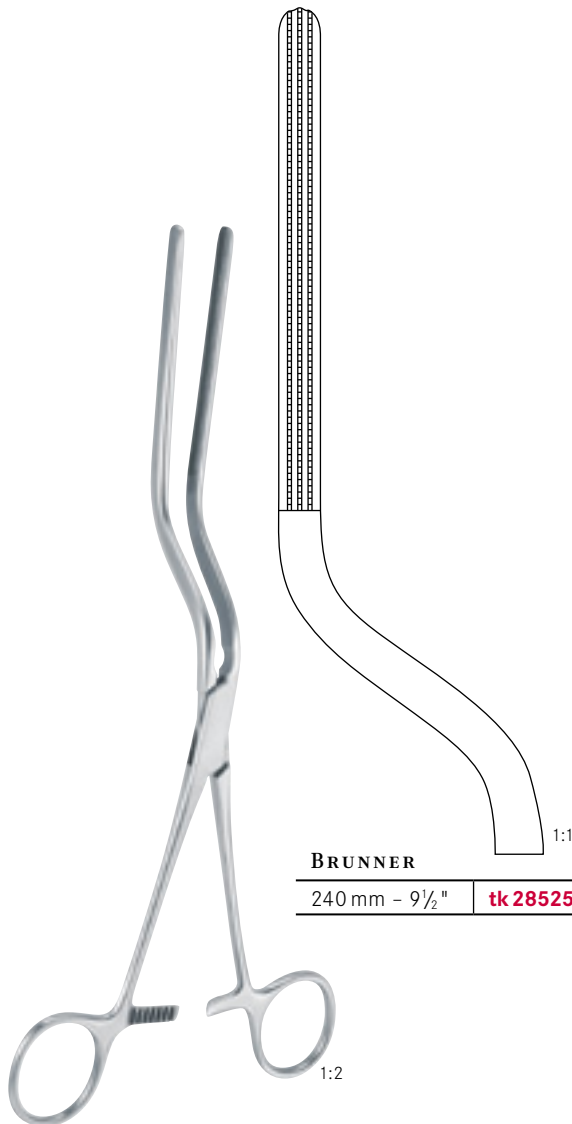

**BRUNNER**

240 mm – 9½"

**tk 28525-24**



**Atraumatische Organfasszangen**  
*Atraumatic organ grasping forceps*

Pinces atraumatiques pour saisir des organes  
*Pinzas atraumaticas para sacar órganos*  
Pinze atraumatiche per afferrare organi

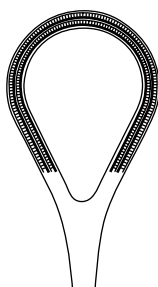

250 mm - 9 3/4" **tk 22014-25**

**Organfasszange mittel, 250 mm**  
*Organ grasping forceps medium, 250 mm*

Pince medium pour saisir des organes, 250 mm  
*Pinza mediano para sacar órganos, 250 mm*  
Pinza per afferrare organi, 250 mm

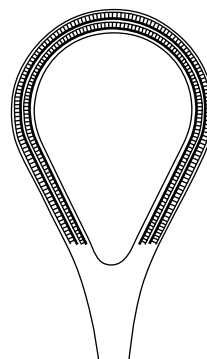

260 mm - 10 1/4" **tk 22014-26**

**Organfasszange gross, 260 mm**  
*Organ grasping forceps large, 260 mm*

Pince grande pour saisir des organes, 260 mm  
*Pinza grande para sacar órganos, 260 mm*  
Pinza per afferrare organi, 260 mm

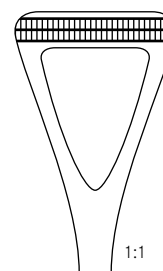
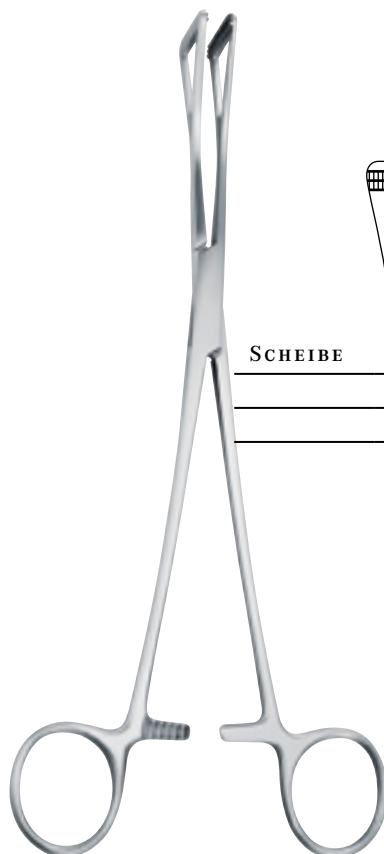

**SCHEIBE**

180 mm - 7"	200 mm - 8"	230 mm - 9"
<b>tk 28470-18</b>	<b>tk 28470-20</b>	<b>tk 28470-23</b>

**schmal**  
*narrow*  
étroit  
*estrecho*  
stretto

**mittel**  
*medium*  
moyen  
*mediano*  
medio

**breit**  
*wide*  
large  
*ancho*  
largo

Darmquetschklemmen  
*Intestinal and pylorus clamps*

Ecraseur pour l'intestin  
*Pinzas intestinales para píloro*  
Schiacciatori intestinali



PAYR-BABY

150 mm – 6"	<b>tk 28410-15</b>
-------------	--------------------

mit Stift  
*with pin*

avec cheville  
*con pivote*  
con perno

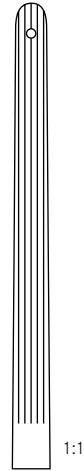

PAYR

210 mm – 8¼"	290 mm – 11½"
<b>tk 28410-21</b>	<b>tk 28410-29</b>

mit Stift  
*with pin*

avec cheville  
*con pivote*  
con perno

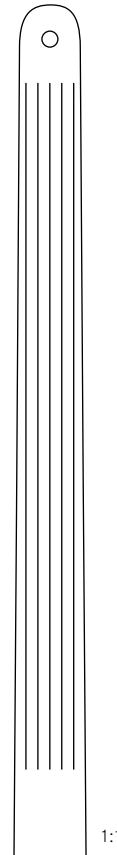
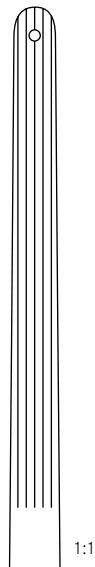

**Darm- und Darm-Anastomosenklemmen**  
*Intestinal and Intestinal Anastomosis clamp forceps*

Pinces-clamps intestinales et à anastomose intestinales  
*Pinzas-clamps intestinales y para anastomosis intestinales*  
 Pinze intestinali e pinze per anastomosi intestinali



1:2

85 mm - 3¼" **tk 28452-08**

**DE MARTEL-  
WOLFSON**



1:2

230 mm - 9" **tk 28452-23**



1:2

**DE MARTEL-  
WOLFSON**

260 mm - 10¼" **tk 28451-26**

Darm- und Anastomosenklemmen  
*Intestinal and anastomosis clamp forceps*

Pinces-clamps intestinales et à anastomose  
*Pinzas-clamps intestinales y para anastomosis*  
 Pinze intestinali e per anastomosi



DE MARTEL-  
WOLFSON



50 mm - 2"	70 mm - 2 <sup>3</sup> / <sub>4</sub> "	100 mm - 4"
<b>tk 28450-05</b>	<b>tk 28450-07</b>	<b>tk 28450-10</b>

Satz mit 3 Klemmen  
*Set of 3 clamps*  
 Jeu de 3 clamps  
*Juego de 3 pinzas*  
 Serie di 3 pezzi

**Mastdarm-Spekula**  
*Rectal specula*

Spéculums pour le rectum  
*Especulos rectales*  
Specoli rettali



**SIMS**

	x=80 mm x 15 mm	x=80 mm x 15 mm
150 mm - 6"	<b>tk 29001-15</b>	<b>tk 29002-15</b>

gefenstert  
*fenestrated*  
fenêtré  
*fenestrado*  
finestrato



**MATHIEU**

	x=90 mm
195 mm - 7¾"	<b>tk 29003-19</b>

Mastdarm-Spekula  
*Rectal specula*

Spéculums pour le rectum  
*Espéculos rectales*  
Specoli rettali



**PRATT**

	x = 80 mm x 25 mm
205 mm – 8"	<b>tk 29006-20</b>



**CZERNY**

	x = 110 mm x 25 mm
220 mm – 8¾"	<b>tk 29004-22</b>

**Anuskope, Proktoskope, Rektoskope, Sphinkterskope**  
*Anoscopes, Proctoscopes, Rectoscopes, Sphincteroscopes*

**Anuscopes, Proctoscopes, Rectoscopes, Sphincteroscopes**  
*Anoscopios, Proctoscopios, Rectoscopios, Esfinteroscopios*  
 Anoscopi, Proctoscopios, Rectoscopios, Sfinteroscopi



**IVES-FANSLER**

	x=90mm
22 mm Ø	<b>tk 29011-80</b>

1:2



**FANSLER**

	x=65mm
25 mm Ø	<b>tk 29011-91</b>
29 mm Ø	<b>tk 29011-90</b>
38 mm Ø	<b>tk 29011-92</b>

1:2

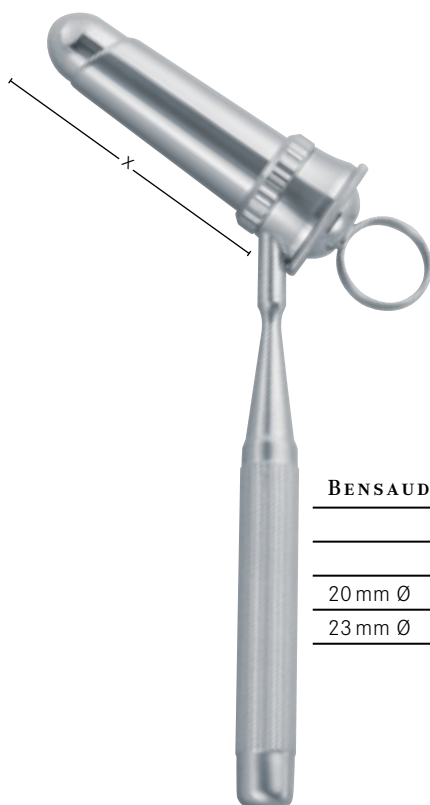

**BENSAUDE**

	185 mm - 7¼"
	x = 55 mm
20 mm Ø	<b>tk 29067-20</b>
23 mm Ø	<b>tk 29067-23</b>



**KELLY**

	x = 50 mm
21 mm Ø	<b>tk 29012-50</b>
27 mm Ø	<b>tk 29013-50</b>

Anuskope, Proktoskope, Rektoskope, Sphinkterskope  
*Anoscopes, Proctoscopes, Rectoscopes, Sphincteroscopes*

Anuscopes, Proctoscopes, Rectoscopes, Sphinctérosopes  
*Anoscopios, Proctoscopios, Rectoscopios, Esfinteroscopios*  
 Anoscopi, Proctoscopios, Rectoscopios, Sfinteroscopi

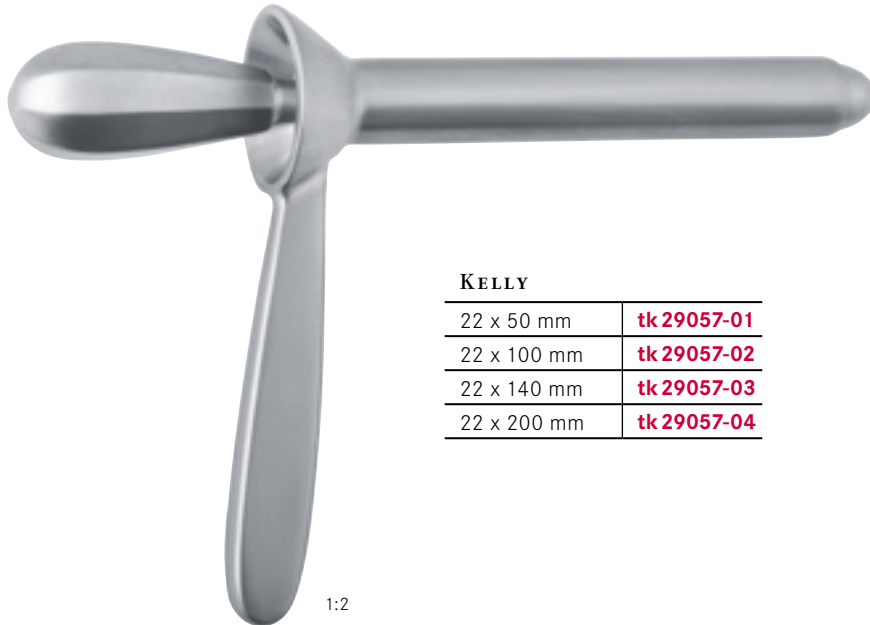

**KELLY**

22 x 50 mm	<b>tk 29057-01</b>
22 x 100 mm	<b>tk 29057-02</b>
22 x 140 mm	<b>tk 29057-03</b>
22 x 200 mm	<b>tk 29057-04</b>

1:2



**HIRSCHMANN**

16 mm Ø	x = 65 mm	<b>tk 29065-16</b>
19 mm Ø	x = 65 mm	<b>tk 29065-19</b>
22 mm Ø	x = 65 mm	<b>tk 29065-22</b>

1:2

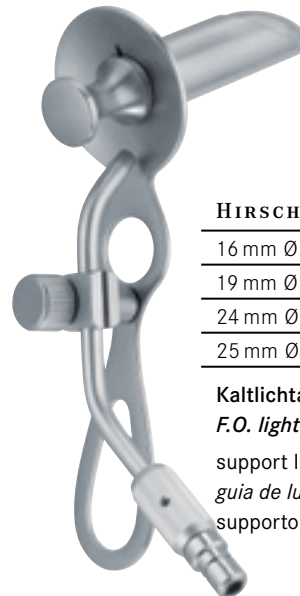

**HIRSCHMANN**

16 mm Ø	<b>tk 29063-16</b>
19 mm Ø	<b>tk 29063-19</b>
24 mm Ø	<b>tk 29063-24</b>
25 mm Ø	<b>tk 29063-25</b>

Kaltlichtaufsatz, Wolf  
*F.O. light carrier, Wolf*  
 support lumière froide, Wolf  
*guía de luz fría, Wolf*  
 supporto per luce fredda, Wolf

**tk 700-997**

Kaltlichtadapter, TEKNO/Storz Anschluss  
*Cold light, TEKNO/Storz connector*  
 Adapteur lum. froide, connection TEKNO/Storz  
*Adaptator luz fría, conexión TEKNO/Storz*  
 Adattatore luce freddo, attacco TEKNO/Storz



Anal spreizer  
Rectal specula

Spéculums pour le rectum  
Espéculos rectales  
Divaricatore anale



ALAN PARKS

140 mm - 5½" tk 29022-00

komplett mit 2 Paar Valven und 1 Mittelvalve, mit Kaltlichtanschluss TEKNO/Wolf  
complete with 2 pair of blades and 1 center blade, with cold light connector TEKNO/Wolf  
complet avec 2 paires des valves et 1 valve centrale, avec raccord de lum. froide TEKNO/Wolf  
completo con 2 juegos de valvas y 1 valva central, con connector de luz fría TEKNO/Wolf  
completo con 2 paia di valve e 1 valva centrale, con attacco di luce fredda TEKNO/Wolf

tk 29022-01

Kaltlicht-Aufsatz  
F.O. light carrier

Support lumière froide  
Soporte de luz fría  
Supporto per luce fredda



SMITH-BUIE

	x = 75 mm x 23 mm
150 mm - 6"	tk 29070-15

Max. Spreizweite 115 mm  
Max. spread 115 mm

Écartement maximal 115 mm  
Apertura máxima 115 mm  
Apertura massima 115 mm

**Analpreizer**  
*Rectal specula*

Spéculums pour le rectum  
*Espéculos rectales*  
Divaricatore anale



1:2

**ALAN PARKS**

140 mm – 5½" | **tk 29020-00**

komplett mit 2 Paar Valven und 1 Mittelvalve  
*complete with 2 pair of blades and 1 center blade*

complet avec 2 paires des valves et 1 valve centrale  
*completo con 2 juegos de valvas y 1 valva central*  
completo con 2 paia di valve e 1 valva centrale

22 mm x 75 mm | **tk 29020-02**

**Seitenvalven alleine (Paar)**  
*Lateral blades only (pair)*

Valves latérales seules (paire)  
*Valvas laterales solas (par)*  
Valve laterali solo (paio)

22 mm x 95 mm | **tk 29020-04**

**Seitenvalven alleine (Paar)**  
*Lateral blades only (pair)*

Valves latérales seules (paire)  
*Valvas laterales solas (par)*  
Valve laterali solo (paio)

25 mm x 95 mm | **tk 29020-06**

**Mittelvalve alleine**  
*Central blade only*

Valve centrale seule  
*Valva central sola*  
Valva centrale solo

Rektoskop  
*Rectoscope*

Rectoscope  
*Rectoscopio*  
Rettoscopio

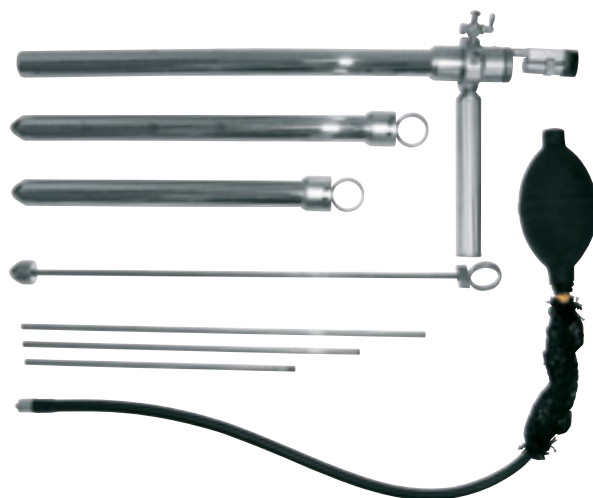

**STRAUSS**

**tk 28531-01**

Kaltlicht-Rektoskop, komplett:

F/O Rektoskopkopf mit Zweiwegehahn, Verschlussdeckel, Teleskop und Griff,  
je 1 Rektoskoptubus in 200 mm, 250 mm und 300 mm mit 20 mm Ø,  
mit Obturator und F/O Lichtträger Wolf-Anschluss, Doppelgebläse mit Kaltlichteinrichtung

*Cold-light rectoscope, complete:*

*F/O Rectoscope-head with two-way stop cock, lens cover and telescope handle,  
3 rectoscope-tubes 20 mm Ø 200 mm, 250 mm and 300 mm  
with obturator and F/O light-carrier Wolf, with double blower, with cold light connection*

Rectoscope à lumière froide, complet:

F/O tête de rectoscope avec robinet, protecteur de lentille, optique et manche,  
3 tubes de rectoscope 20 mm Ø, 200 mm, 250 mm et 300 mm de longueur,  
avec mandrin et porte-lumière Wolf (F/O), souffleur et connecteur de lumière froide.

*Rectoscopio de luz fría, completo:*

*F/O cabeza de rectoscopio, con robinete protector de lentes, optica y mango,  
3 tubos de rectoscopia de 20 mm, Ø 200 mm, 250 mm y 300 mm de longitud,  
con obturador y conector de luz fría Wolf y soplador.*

Luce fredda-Rettoscopio, completo

Testa di rettoscopio con fibre ottiche, con rubinetto a due vie, copri-lente e impugnatura per ottica,  
3 tubi per rettoscopio 20 mm Ø, 200 mm, 250 mm e 300 mm  
con otturatore e cavo luce, insufflatore a doppia palla e connettore per cavo luce, allacciamento Wolf.

**tk 700-997**

Kaltlichtadapter TEKNO/Storz

*Cold light connector TEKNO/Storz*

Raccord de lumière froide TEKNO/Storz

*Connector de luz fría TEKNO/Storz*

Attacco luce fredda TEKNO/Storz

Mastdarm-Biopsiezangen  
Rectal biopsy forceps

Pinces pour la biopsie rectale  
Pinzas para biopsia rectal  
Pinze taglianti per biopsia rettale

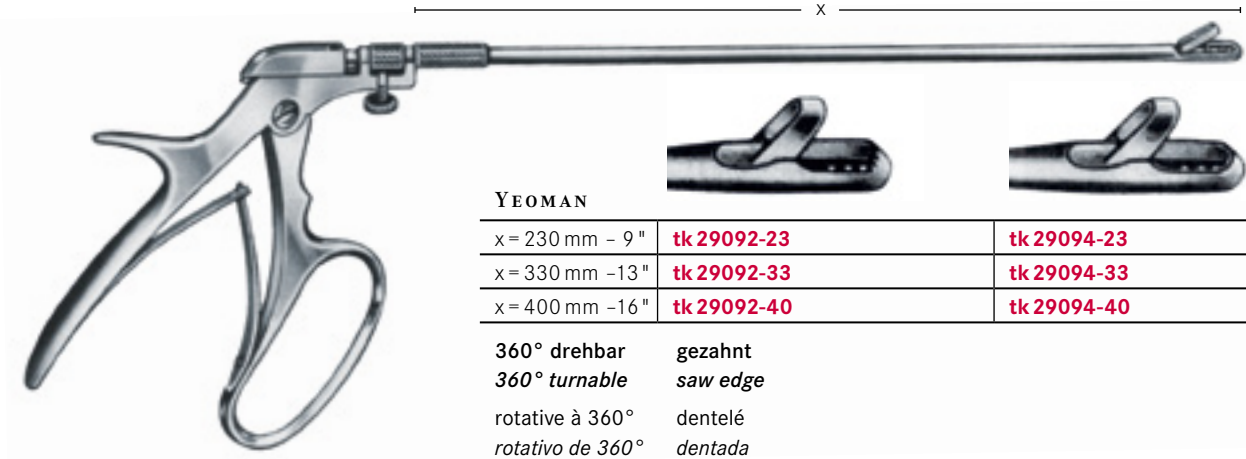

YEOMAN

x = 230 mm - 9"	<b>tk 29092-23</b>	<b>tk 29094-23</b>
x = 330 mm -13"	<b>tk 29092-33</b>	<b>tk 29094-33</b>
x = 400 mm -16"	<b>tk 29092-40</b>	<b>tk 29094-40</b>

360° drehbar      gezahnt  
360° turnable    saw edge  
rotative à 360°    dentelé  
rotativo de 360°    dentada  
rotativa di 360°    dentata





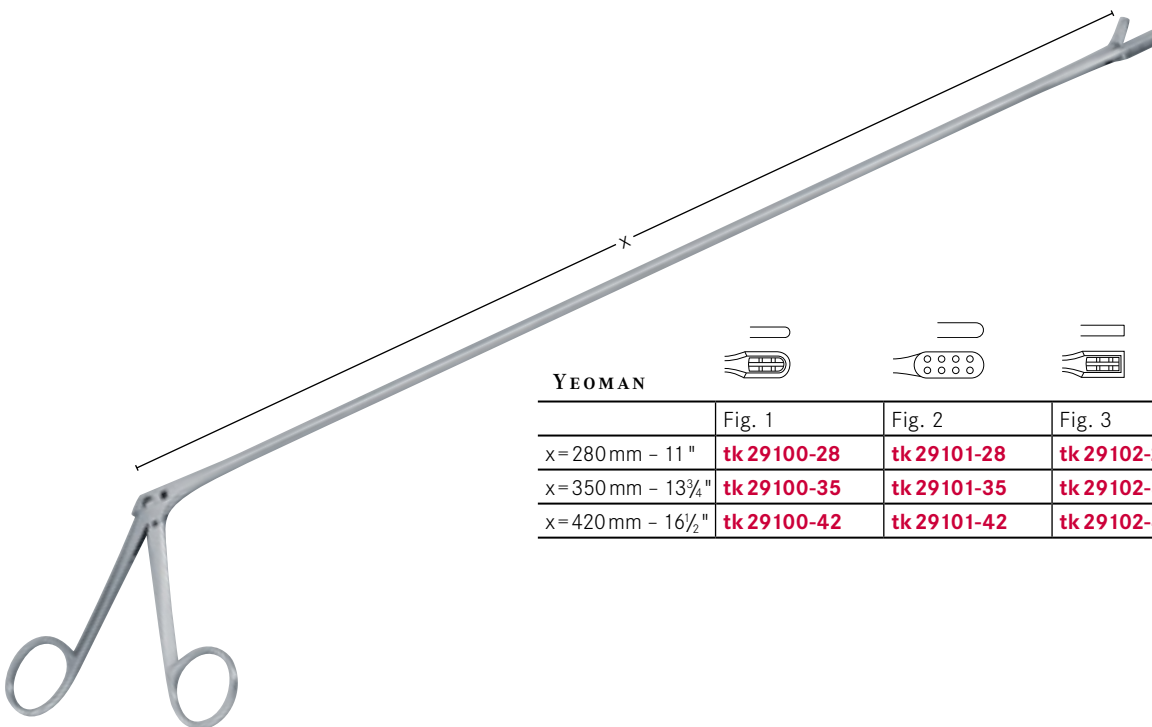

TURREL

x = 230 mm - 9"	<b>tk 29096-23</b>	<b>tk 29098-23</b>
x = 330 mm -13"	<b>tk 29096-33</b>	<b>tk 29098-33</b>
x = 400 mm -16"	<b>tk 29096-40</b>	<b>tk 29098-40</b>

360° drehbar      gezahnt  
360° turnable    saw edge  
rotative à 360°    dentelé  
rotativo de 360°    dentada  
rotativa di 360°    dentata



YEOMAN

				
	Fig. 1	Fig. 2	Fig. 3	Fig. 4
x = 280 mm - 11"	<b>tk 29100-28</b>	<b>tk 29101-28</b>	<b>tk 29102-28</b>	<b>tk 29103-28</b>
x = 350 mm - 13¾"	<b>tk 29100-35</b>	<b>tk 29101-35</b>	<b>tk 29102-35</b>	<b>tk 29103-35</b>
x = 420 mm - 16½"	<b>tk 29100-42</b>	<b>tk 29101-42</b>	<b>tk 29102-42</b>	<b>tk 29103-42</b>

**Flexible Zangen**  
*Flexible forceps*

Pinces flexibles  
*Pinzas flexibles*  
Pinze flessibili



	1.8 mm Ø	2.2 mm Ø	2.6 mm Ø	3.4 mm Ø
1200 mm - 47 <sup>1</sup> / <sub>4</sub> "	<b>tk 31100-12</b>	<b>tk 31110-12</b>		
1600 mm - 63"	<b>tk 31100-16</b>	<b>tk 31110-16</b>	<b>tk 31120-16</b>	<b>tk 31130-16</b>
1800 mm - 70 <sup>3</sup> / <sub>4</sub> "	<b>tk 31100-18</b>	<b>tk 31110-18</b>		
2300 mm - 90 <sup>1</sup> / <sub>2</sub> "	<b>tk 31100-23</b>	<b>tk 31110-23</b>	<b>tk 31120-23</b>	<b>tk 31130-23</b>



	1.8 mm Ø	2.2 mm Ø	2.6 mm Ø	3.4 mm Ø
1200 mm - 47 <sup>1</sup> / <sub>4</sub> "	<b>tk 31101-12</b>	<b>tk 31111-12</b>		
1600 mm - 63"	<b>tk 31101-16</b>	<b>tk 31111-16</b>	<b>tk 31121-16</b>	<b>tk 31131-16</b>
1800 mm - 70 <sup>3</sup> / <sub>4</sub> "	<b>tk 31101-18</b>	<b>tk 31111-18</b>		
2300 mm - 90 <sup>1</sup> / <sub>2</sub> "	<b>tk 31101-23</b>	<b>tk 31111-23</b>	<b>tk 31121-23</b>	<b>tk 31131-23</b>



	1.8 mm Ø	2.2 mm Ø	3.4 mm Ø
1200 mm - 47 <sup>1</sup> / <sub>4</sub> "	<b>tk 31102-12</b>	<b>tk 31112-12</b>	
1600 mm - 63"	<b>tk 31102-16</b>	<b>tk 31112-16</b>	<b>tk 31132-16</b>
1800 mm - 70 <sup>3</sup> / <sub>4</sub> "	<b>tk 31102-18</b>	<b>tk 31112-18</b>	
2300 mm - 90 <sup>1</sup> / <sub>2</sub> "	<b>tk 31102-23</b>	<b>tk 31112-23</b>	<b>tk 31132-23</b>



	1.8 mm Ø	2.2 mm Ø	3.4 mm Ø
1200 mm - 47 <sup>1</sup> / <sub>4</sub> "	<b>tk 31103-12</b>	<b>tk 31113-12</b>	
1600 mm - 63"	<b>tk 31103-16</b>	<b>tk 31113-16</b>	<b>tk 31133-16</b>
1800 mm - 70 <sup>3</sup> / <sub>4</sub> "	<b>tk 31103-18</b>	<b>tk 31113-18</b>	
2300 mm - 90 <sup>1</sup> / <sub>2</sub> "	<b>tk 31103-23</b>	<b>tk 31113-23</b>	<b>tk 31133-23</b>

Flexible Zangen  
Flexible forceps

Pinces flexibles  
Pinzas flexibles  
Pinze flessibili



	1.8 mm Ø	2.2 mm Ø
1600 mm – 63"	<b>tk 31140-16</b>	<b>tk 31150-16</b>
2300 mm – 90½"	<b>tk 31140-23</b>	<b>tk 31150-23</b>



	1.8 mm Ø	2.2 mm Ø
1600 mm – 63"	<b>tk 31142-16</b>	<b>tk 31152-16</b>
2300 mm – 90½"	<b>tk 31142-23</b>	<b>tk 31152-23</b>



	1.8 mm Ø	2.2 mm Ø
1600 mm – 63"	<b>tk 31143-16</b>	<b>tk 31153-16</b>
2300 mm – 90½"	<b>tk 31143-23</b>	<b>tk 31153-23</b>



	1.8 mm Ø	2.2 mm Ø
1600 mm – 63"	<b>tk 31146-16</b>	<b>tk 31156-16</b>
2300 mm – 90½"	<b>tk 31146-23</b>	<b>tk 31156-23</b>



	1.8 mm Ø	2.2 mm Ø
1600 mm – 63"	<b>tk 31147-16</b>	<b>tk 31157-16</b>
2300 mm – 90½"	<b>tk 31147-23</b>	<b>tk 31157-23</b>

Hämorrhoidal-Zangen  
*Haemorrhoidal forceps*

Pincas hémorroidales  
*Pinzas hemorroidales*  
 Pinze emorroidali



MC GIVNEY

190 mm - 7 1/2"

tk29111-19

1x gebogen  
*single curved*  
 courbé simple  
*curvado simple*  
 curvatura singola

tk29112-19

2x gebogen  
*double curved*  
 courbé double  
*curvado doble*  
 curvatura doppia

Polypenfasszangen  
*Polypus grasping forceps*

Pinces pour saisir polypes  
*Pinzas para coger pólipos*  
Pinze per afferrare polipi

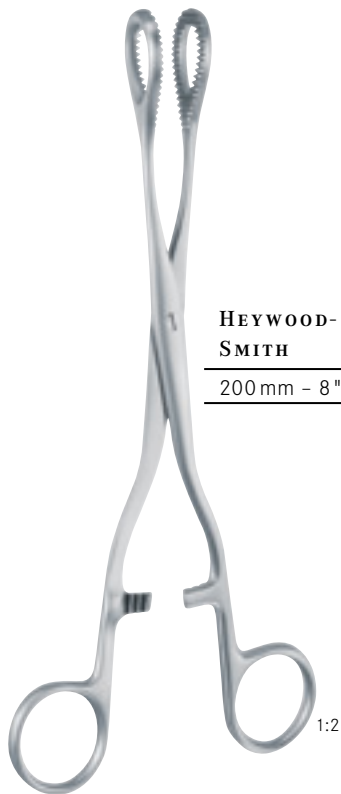

HEYWOOD-  
SMITH

200mm - 8"

**tk 29114-20**

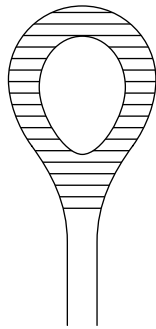

HEYWOOD-  
SMITH

210mm - 8¼"

**tk 29115-21**

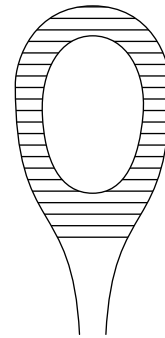



Hämorrhoidal-Ligatoren  
*Haemorrhoidal ligators*

Ligateurs hémorroïdales  
*Ligadores hemorroidales*  
Legatori emorroidali

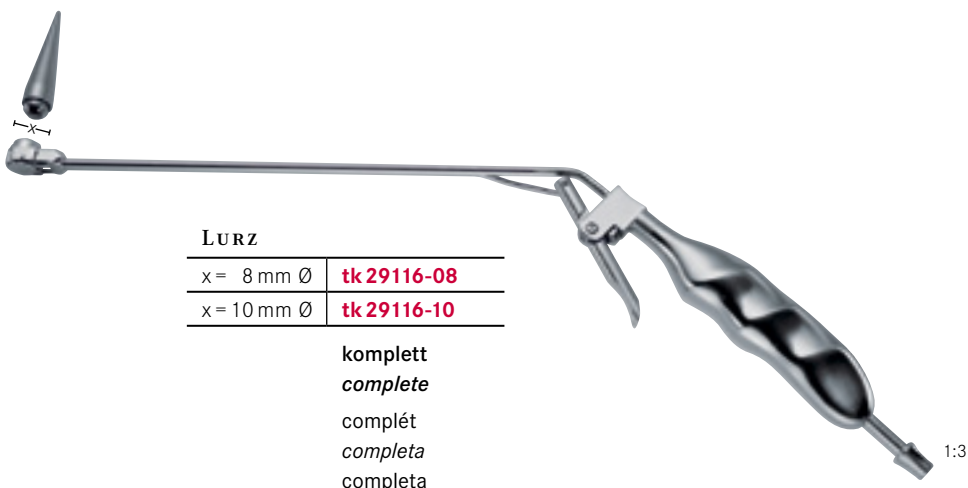

## LURZ

x = 8 mm Ø	<b>tk 29116-08</b>
x = 10 mm Ø	<b>tk 29116-10</b>

komplett  
*complete*  
complét  
*completa*  
completa

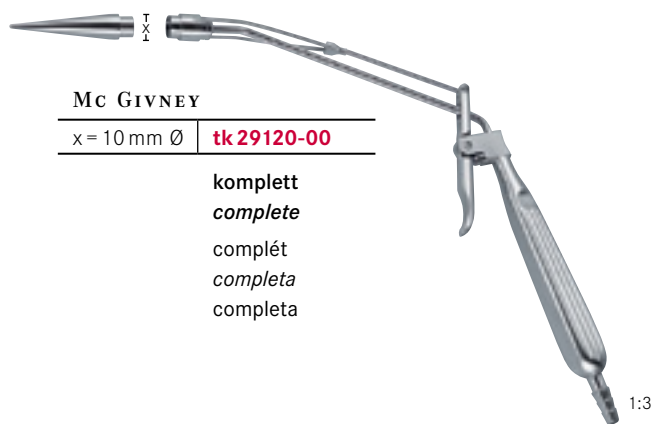

## MC GIVNEY

x = 10 mm Ø	<b>tk 29120-00</b>
-------------	--------------------

komplett  
*complete*  
complét  
*completa*  
completa

**tk 29140-00**

Gummiringe, Packung à 100 Stück  
*Rubber rings, package of 100 pieces*

Anneaux de caoutchouc à ligatures, paquet de 100 pièces  
*Anillos de goma para ligaduras, paquete de 100 piezas*  
Anelli di gomma, pacchetto di 100 pezzi

Hämorrhoidal-Ligatoren  
*Haemorrhoidal ligators*

Ligateurs hémorroïdales  
*Ligadores hemorroidales*  
Legatori emorroidali

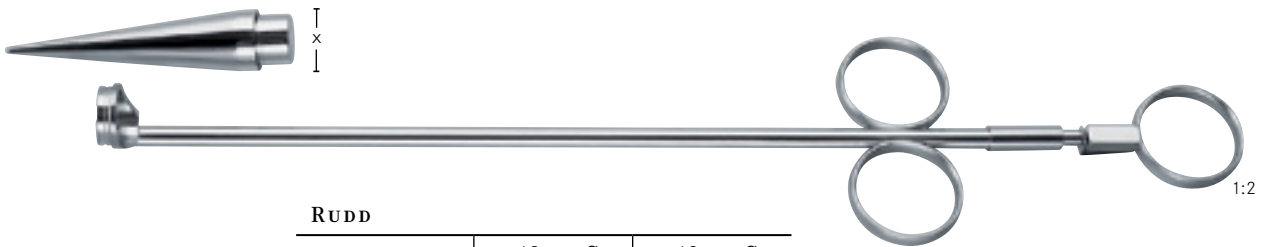

RUDD		
	x = 12 mm Ø	x = 12 mm Ø
315 mm - 12½"	<b>tk 29130-00</b>	<b>tk 29130-01</b>

komplett	Ladekegel allein
<i>complete</i>	<i>Cone piece only</i>
complét	Cône seule
<i>completa</i>	<i>Cono solo</i>
completa	Cono solo

**tk 29140-00**

Gummiringe, Packung à 100 Stück  
*Rubber rings, package of 100 pieces*

Anneaux de caoutchouc à ligatures, paquet de 100 pièces  
*Anillos de goma para ligaduras, paquete de 100 piezas*  
Anelli di gomma, pacchetto di 100 pezzi